





Quick Start

GPX-4000

- 1** Set the front panel switches to the following positions:

Search Mode	Soil / Timings	Ground Balance	Coil / Rx
Patch	Sensitive	Fixed	Double D
 G	 N		 M
Deep	Salt	Tracking	Cancel

- 2** Press the On/Off button on the rear control panel. (pg. 25)
- 3** Turn the Threshold control up until a tone is audible through the headphones. (pg. 34)
- 4** Raise the coil off the ground and Press the Auto Tune button to reduce electrical interference. The tuning process takes approximately 60 seconds. Do not move the coil or pass metal objects near the coil during the tuning process. (pg. 33)
- 5** Whilst lowering and raising the coil between 25mm and 100mm (1" and 4") from the ground, change the Ground Balance switch to Tracking. Any variations in the Threshold will smooth out within 3-5 seconds. (pg. 40)
- 6** Adjust the Threshold to a very faint but still audible level. It should be smooth with only minor fluctuations. (pg. 34)

You are now ready to start searching!



Ground Balance

Fixed



Minelab is always interested in your opinions. If you have any questions or comments regarding the GPX-4000 or any other Minelab product, please feel free to contact us via your local Authorised Minelab dealer, or write to us:



Minelab Electronics Pty Ltd

PO Box 537, Torrensville Plaza
Adelaide, South Australia, 5031
Australia
Tel: +61 (0) 8 8238 0888
Fax: +61 (0) 8 8238 0890
Email: minelab@minelab.com.au



Minelab International Ltd

Laragh, Bandon
Co. Cork
Ireland
Tel: +353 (0) 23 52101
Fax: +353 (0) 23 52106
Email: minelab@minelab.ie

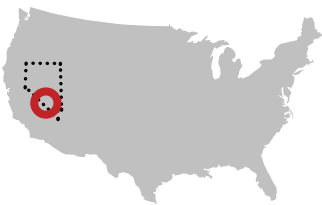

Minelab USA Inc

871 Grier Drive, Suite B1
Las Vegas, Nevada, 89119
USA
Tel: +1 702 891 8809
Fax: +1 702 891 8810
Email: info@minelabusa.com

For further product information and detecting tips, refer to:

WWW.MINELAB.COM



The World Leader in Metal Sensing Technology

From our origins in 1985, Minelab have specialised in advanced electronics technologies. Our competitive advantage was created almost immediately with a highly competent and innovative Research and Development team, inspired by the genius of Mr. Bruce Candy.

This commitment to innovation has enabled us to successfully market feature-packed Consumer coin and treasure detectors enjoyed by hobbyists worldwide as well as high quality gold detectors used by both professionals and amateurs. Minelab's advanced technology is also incorporated in detection equipment designed for military and humanitarian de-mining projects throughout the world.

Today Minelab has manufacturing, distribution and customer service operations in Australia, Europe and the United States, and is an ISO 9001 Quality Endorsed Company. ISO 9001 is a worldwide quality standard certification that ensures the highest level of product quality for our customers.

© Minelab Electronics Pty Ltd

This document contains proprietary information which is protected by copyright. Apart from any use as permitted under the Copyright Act 1968, no part may be reproduced by any process without written permission from Minelab Electronics Pty Ltd, 118 Hayward Avenue, Torrensville, SA 5031, Australia.

WARNING. This document contains Minelab Electronics Pty Ltd rights, technical data or restricted rights data, or both. Patents and trademarks apply.

Working for a Cleaner, Greener Future



For Consumers within the European Union: Do not dispose of this equipment in general household waste.

The crossed out wheeled bin indicated on this equipment is an indicator that this unit should not be disposed of in general household waste, but recycled in compliance with local government regulations or environmental requirements.

Please dispose of this equipment via a recycling service or centre, or by returning the unit to the respective Minelab or Halcro outlet as appropriate for your unit. This will enable the equipment to be disposed of in an environmentally safe manner.

Disposal of unwanted electronic equipment in landfilled waste may contribute to adverse long term environmental effect due to the leaching of contaminating and toxic substances contained within some electronic equipment.

Disclaimer:

The Minelab metal detector discussed in this operating manual has been expressly designed and manufactured as a quality hobbyist metal detector and is recommended for use in coin, treasure and general metal detection in non-hazardous environments. This metal detector has not been designed for use as a mine detector or as a live munitions detection tool.

Please note:

Since there may be a variety of options available for this detector, equipment may vary according to the Model or items ordered with your detector. Certain descriptions and illustrations may also differ (in this manual) from the exact Model that you purchased. In addition, Minelab reserves the right to respond to ongoing technical progress by introducing changes in design, equipment and technical features at any time.



THIS DEVICE COMPLIES WITH PART 15 OF THE FCC RULES

Operation is subject to the following two conditions: (1) this device may not cause harmful interference, and (2) this device must accept any interference received, including interference that may cause undesired operation.

Item Number: 4901 - 0060
Revision: 1.1

Congratulations on Purchasing the Minelab GPX-4000

1

Gold detecting is a fascinating and rewarding activity enjoyed by people all over the world. By getting to know your GPX-4000 you can become one of the many who find gold and valuable treasure.

The GPX-4000 is Minelab's most advanced gold detector. It is a high precision instrument incorporating Multi-Period Sensing (MPS), Dual Voltage Technology (DVT), and the latest in high-tech analogue components combined with advanced digital processing.

The GPX-4000 will locate gold in all types of terrain, especially highly mineralised ground conditions, with greater efficiency than any previous detector.

This manual is designed to help both the beginner and expert prospector get the best performance out of the GPX-4000.

Minelab wishes you every success in your quest for gold and treasure!

Quick Start	Back Cover
Introducing the GPX-4000	4
List of Parts	6
Assembly	8
Adjusting the Detector for Comfortable Detecting	16
Charging the Battery	18
Battery LED Patterns	20
Taking Care of Your Battery	21
Detecting Basics	22
Detector Sounds	23
Front Control Panel	24
Rear Control Panel	25
Turning the Detector On	26
LCD Menu Structure	27
Search Mode	28
Factory Presets	30
Tune / Reducing Electrical Interference	32
Auto Tune	33
Threshold / Adjusting the Background Audio Level	34
Soil/Timings / Optimising for Soil & Target Types	36
Ground Balance / Reducing Ground Noise	38
Ground Balance Procedure for Tracking	40
Ground Balance Procedure for Fixed	42
Coil/Rx / Changing Sensitivity & Rx Fields of the Coil	44

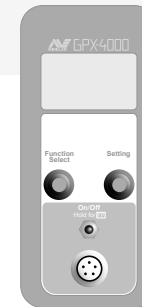

Functions	46
Settings	47
Accessing Functions	48
Accessing Settings	49
Volume Limit / Setting the Max Volume of all Sounds	50
Audio Tone / Adjusting the Pitch of the Threshold	52
Signal Peak / Adjusting Pitch Variation of Target Signals	53
Tracking Speed / Keeping up with Changing Ground	54
Sensitive / Soil/Timings	55
Ground Balance Type	56
Ground Balance Procedure for Specific	57
Iron Reject Off (All Metal) / Accepting All Target Types	58
Iron Reject / Rejecting Iron Targets	60
Battery Test / Viewing the Battery Voltage	62
Manual Tune / Reducing Electrical Interference	63
Audio Type / Changing the Response of Target Signals	64
Gain / Adjusting the Sensitivity of the Detector	65
Motion / Adjusting Sweep Speed	66
Response / Inverting the Pitch of the Target Signal	68
Pinpointing / Locating the Target	70
Recovering the Target	72
Detecting Tips	74
Commander Coils	76
Choosing the Right Coil for the Job	78
User Preferences	80
Troubleshooting	81
Glossary of Terms	82
Taking Care of Your Detector	85
Technical Specifications	86
Warranty	87
Service Repair Form	88

The GPX-4000 utilises Minelab's proven 'Dual Voltage Technology' (DVT). This ensures an accurate Ground Balance to provide maximum sensitivity and depth in all ground types. The GPX-4000 can handle heavily mineralised and salty ground conditions with greater ease than previous detectors, which effectively opens up NEW detecting areas.

The GPX-4000 offers three pre-programmed Search Modes, set up for the three common search techniques – Patch finding; General detecting and Deep slow careful detecting. As you become familiar with all the new functions of the GPX-4000, you can then program your own settings for each Search Mode.

All setting changes are automatically saved when the detector is turned off and loaded when you switch the detector back on. You can also restore the Factory Preset settings at any time.

There is an LCD on the rear of the control box. Simply scroll through the various functions of the detector and adjust the setting. This is more accurate than the old method of turning the control to 'about 2-o'clock'. Now you can accurately compare the effect of different settings and easily remember your preferred levels.

New Functions

Gain – The Gain function sets the overall sensitivity level of your detector. In areas where conditions are mild, you can increase the Gain. In areas that are more difficult, Gain can be reduced.

Timings – The GPX-4000 features an improved set of timings, increasing performance in different conditions.

Ground Balance Type – In addition to Ground Balance there is now the choice of two Ground Balance Types, Normal and Specific. Specific Ground Balance is designed to be used in very hot ground and is especially useful with Monoloop coils.

Response – The Response function allows you to invert the target response. Deep targets can now sound like the more familiar, 'rising and falling' pitch of a shallow target signal.

Motion – The speed at which you sweep the coil has an effect on target response time and Ground Balance adjustment. Matching your preferred coil sweep speed with the corresponding Motion setting can reduce noise.

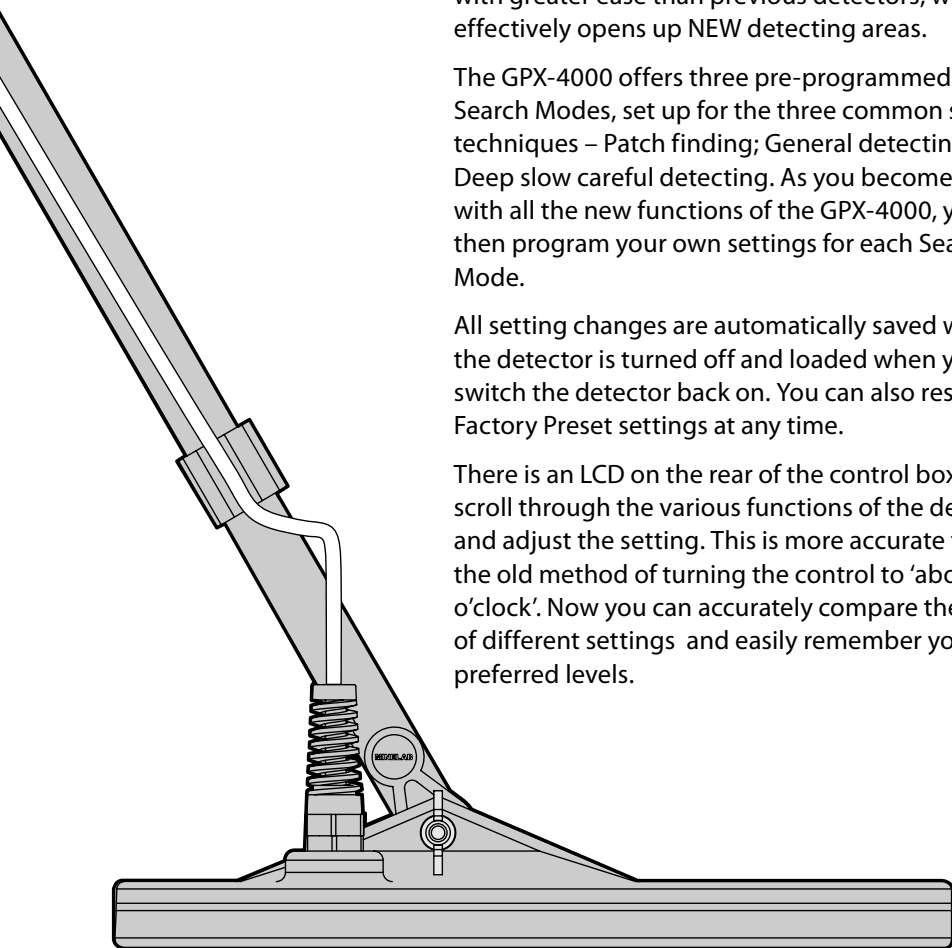

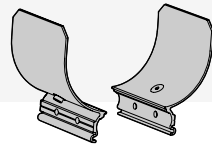

Armrest (2 sections)

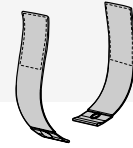

Armrest Straps

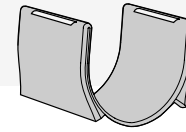

Armrest Cover

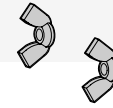

Armrest Wingnuts

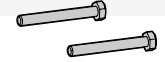

Armrest Bolts

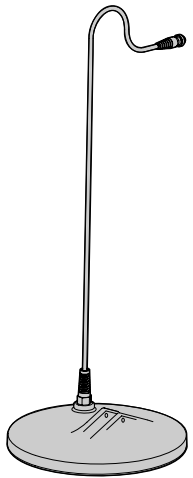

11" DD Coil

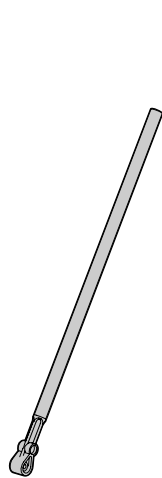

Lower Shaft

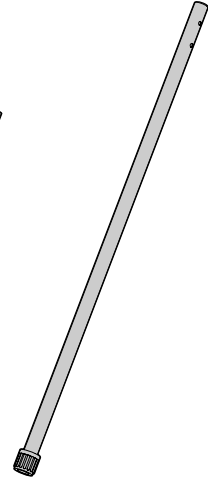

Upper Shaft

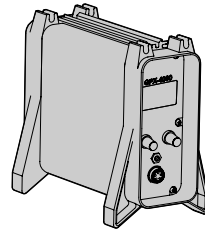

Control Box

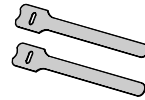

Velcro Tabs

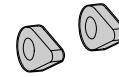

Lower Shaft Washers



Lower Shaft Wingnut



Lower Shaft Bolt

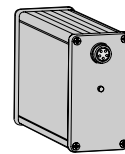

Lithium Ion Battery

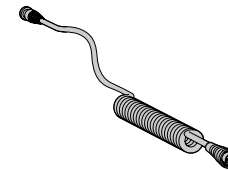

Power Cable

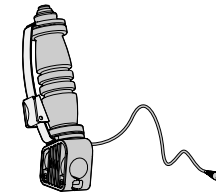

Handle
(with Quick-Trak
Button)

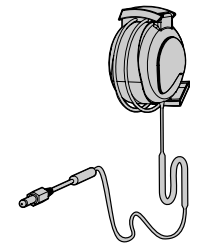

Headphones

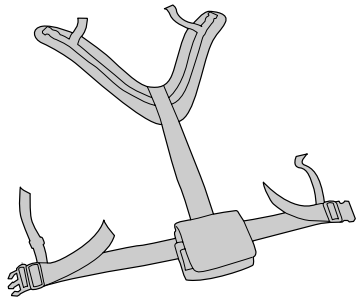

Battery Harness

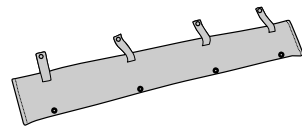

Waistbelt



Bungee Cord Clamp
(Bow Knuckle)
Bolt
Wingnut



Bungee Cord

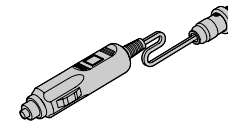

Vehicle Charger Adaptor

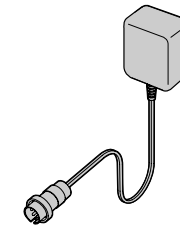

Mains Charger Adaptor

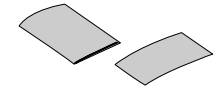

Instruction Manual
Warranty Card

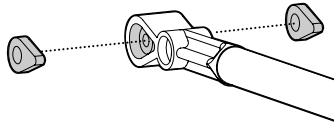

Attaching the Coil to the Lower Shaft:

- 1 Plug the two rubber washers into the holes on either side of the lower shaft.
- 2 Ensure that the spring loaded pin of the lower shaft is pointing downwards. Slide the lower shaft into the bracket on top of the coil.
- 3 Insert the bolt through the lower shaft and the bracket on top of the coil. Fasten with the nut provided, being careful not to damage the thread of the nut by over-tightening. This may need to be loosened to adjust the coil to a comfortable detecting angle.

The coil cable is directly wired into the coil and is not removable. Any attempt to disconnect this cable will void your warranty.

If the coil becomes loose over time, the rubber washers may need to be replaced.

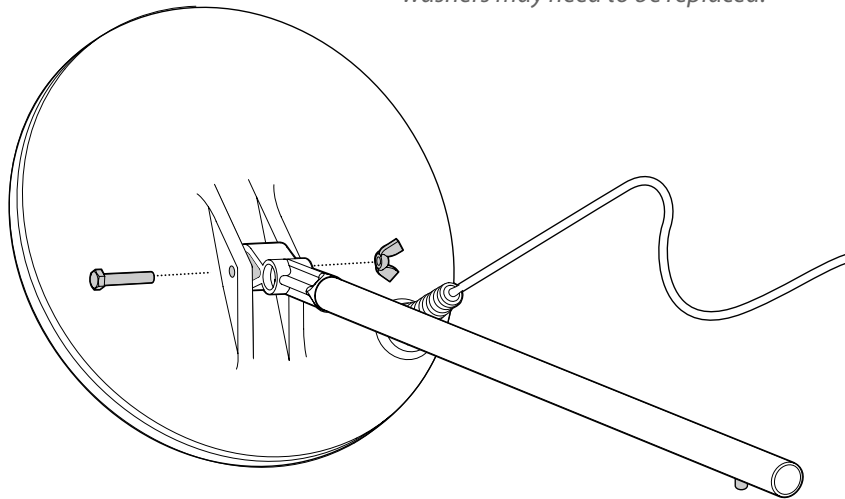

spring loaded pin

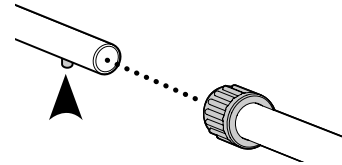
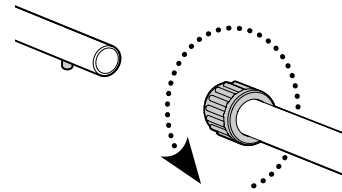
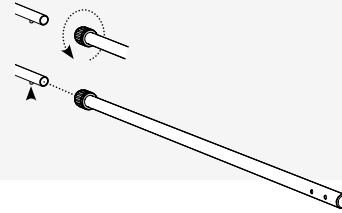

Attaching the Lower Shaft to the Upper Shaft:

- 1 Rotate the twistlock of the upper shaft counter-clockwise to ensure that it is loosened.
- 2 Compress the spring loaded pin of the lower shaft. Slide the lower shaft into the upper shaft until the pin reaches an adjustment hole. The pin will spring out and clip into place.

Attaching the Handle to the Upper Shaft:

- 1 Slide the bungy cord clamp onto the upper shaft.
- 2 Slide the handle onto the upper shaft so that it slopes away from you.

Attaching the Armrest to the Upper Shaft:

- 1 Place the two armrest halves on either side of the upper shaft, aligning the armrest and upper shaft holes.
- 2 Insert the bolts through the armrest and upper shaft holes.
- 3 Loosely fasten the wing-nuts onto the bolts (these will be tightened after the control box is attached).

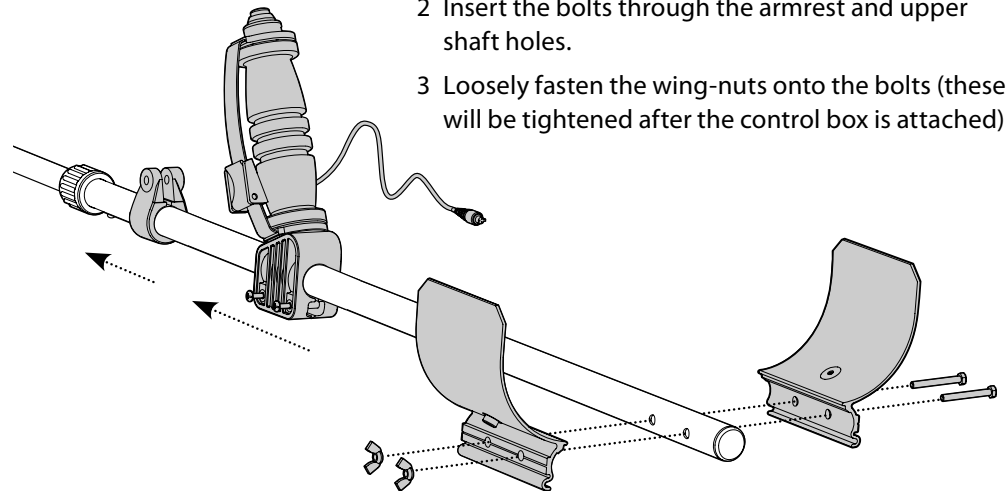

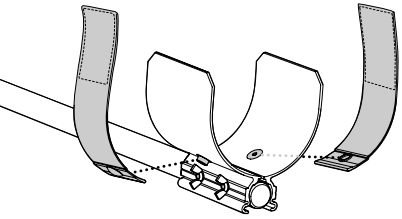

Attaching the Armrest Strap to the Armrest:

- 1 Press both strap studs onto the armrest studs.
- 2 Push the armrest straps through the slots in the armrest cover and then push the cover over the armrest.

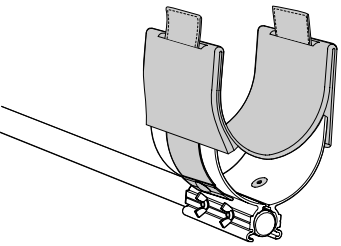

Connecting the Control Box to the Upper Shaft:

- 1 Place the detector on a flat surface, with the handle facing upwards.
- 2 Position the armrest on top of the control box.
- 3 Clip the control box onto the armrest, ensuring that the battery plug faces the rear.
- 4 Fasten with the wing-nuts.
- 5 Wind the Quick-Trak button cable around the upper shaft and plug it into the Smart Point socket in the control box. Ensure that the cable is wrapped firmly, but avoid strain on the connector.

If the Quick-Trak cable becomes loose, try securing it onto the shaft with electrical tape.

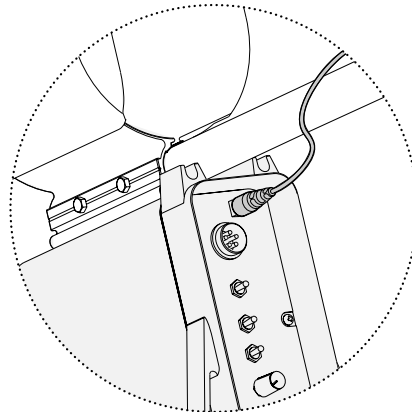
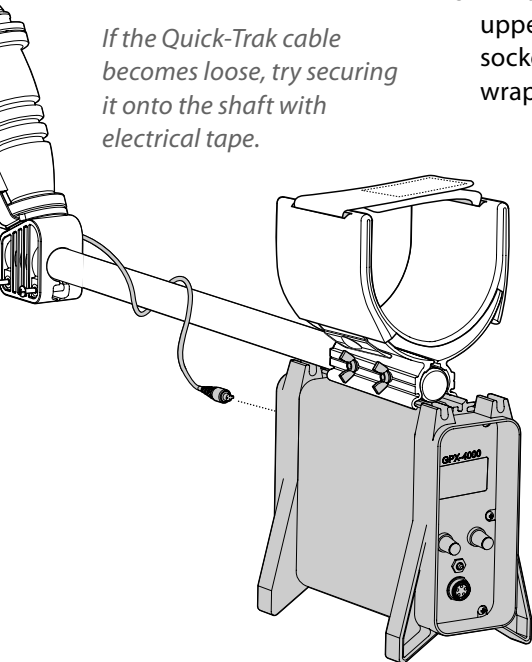

Always ensure that the control box is turned off before connecting or disconnecting the coil to avoid damage to the detector's electronics.

Connecting the Coil Cable:

- 1 Wind the coil cable around the lower and upper shafts enough times to take up the slack. Leave enough slack at the bottom of the cable near the coil to allow the angle of the coil to be adjusted while detecting.
- 2 Use the Velcro straps to keep the coil cable in place against the shaft.
- 3 Plug the coil connector into the coil socket on the control box, firmly tightening the retaining ring to hold it in place.

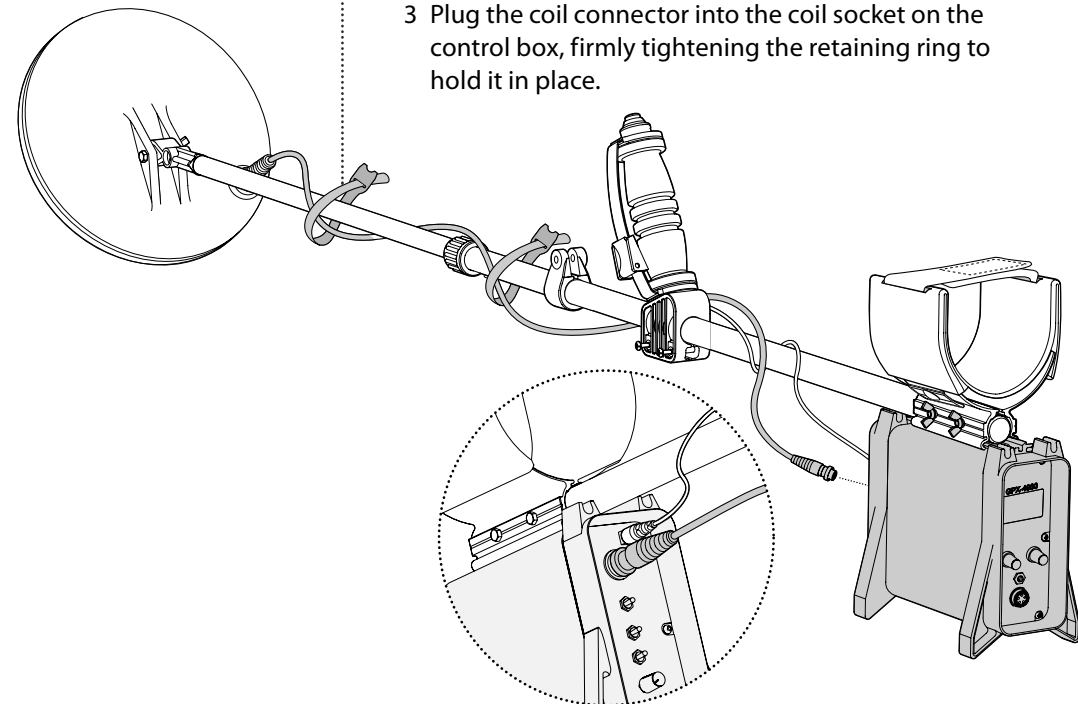

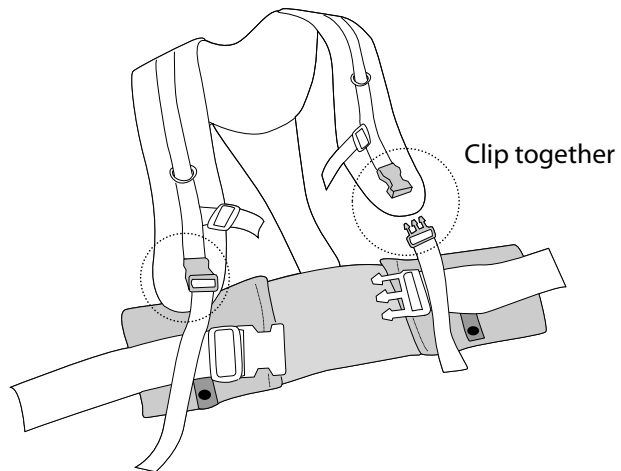
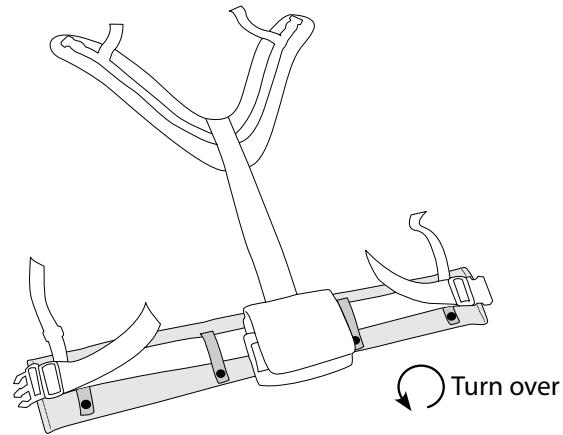
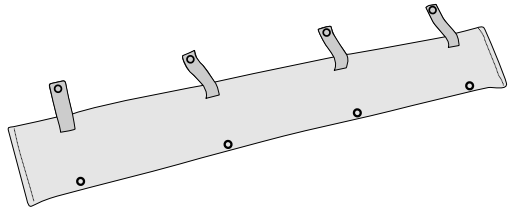

Attaching the Waistbelt to the Battery Harness:

- 1 Place the belt on a flat surface with the studs facing up. Ensure that all the studs are unclipped.
- 2 Place the harness on top of the belt, with the battery pouch facing up. Press the belt studs over the harness strap to hold the belt in place.
- 3 Turn the harness and waistbelt over so that the pouch faces downwards.
- 4 Clip the shoulder strap buckles together.

Connecting the Battery Pack:

- 1 Place the battery into the battery harness pouch.
- 2 Connect the headphones and the power cable to the appropriate sockets in the battery.

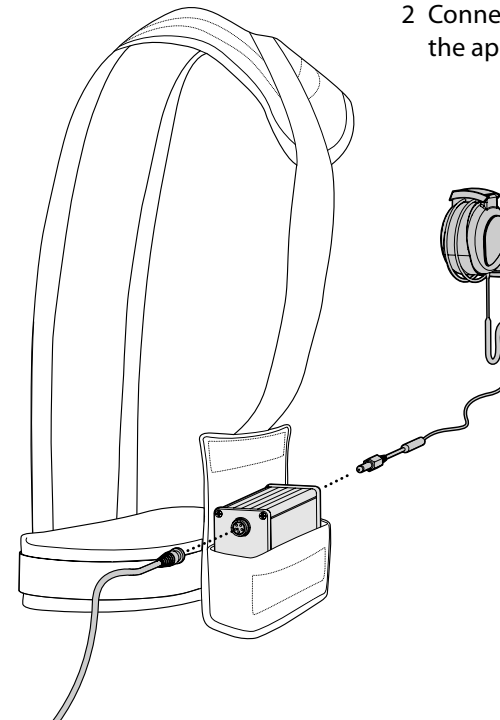

Note: The illustration shows the battery oriented for a user holding the detector with their left hand.

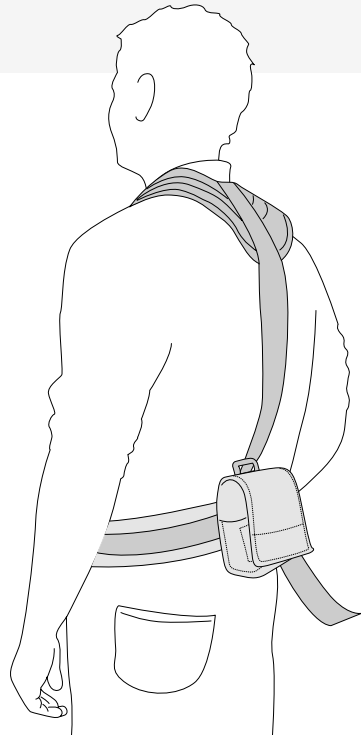
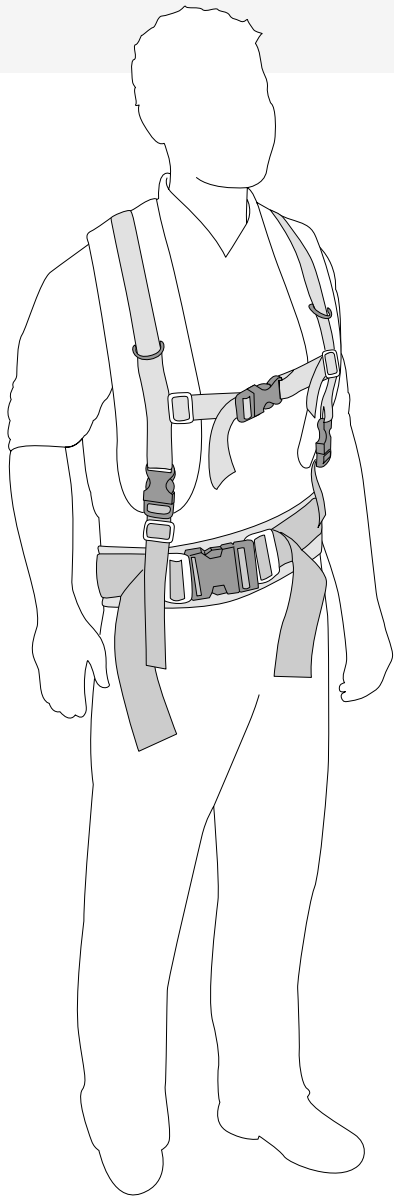

Fitting the Battery Harness:

- 1 Thread your arms through the harness, so the battery pack sits on your back.
- 2 Clip the waist and chest buckles together.

Adjusting the Detector for Comfortable Detecting, pg. 16.

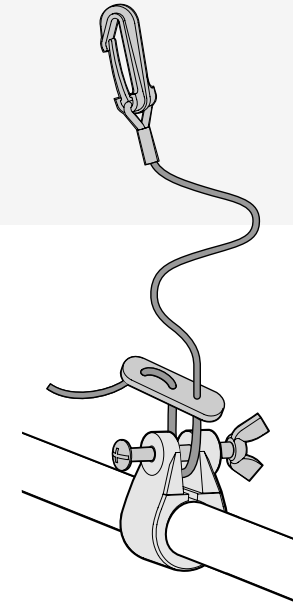
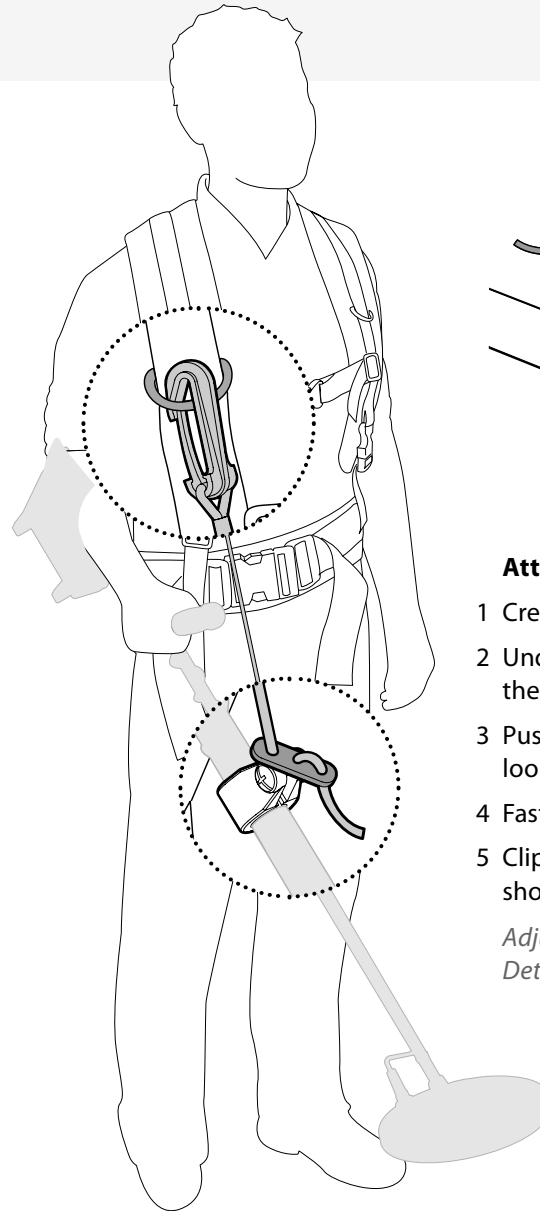

Attaching the Bungee Cord:

- 1 Create a loop in the bungee cord.
- 2 Undo the plastic wing-nut and remove the bolt from the clamp.
- 3 Push the bolt back through the clamp and loop to secure the bungee cord to the shaft.
- 4 Fasten the screw with the wing-nut.
- 5 Clip the bungee cord onto one of the harness shoulder strap rings.

Adjusting the Detector for Comfortable Detecting, pg. 16.

16 Adjusting the Detector for Comfortable Detecting

For comfortable, long term detecting, it is important that you take the time to adjust the detector correctly.



Holding the Detector:

Thread your arm through the armrest and strap. Grasp the handle of the detector and rest your forearm in the armrest.

Adjusting the Position of the Handle:

Your elbow should sit just above the back of the armrest and you should comfortably grip the handle.

Slide the handle into position. Using a screwdriver, tighten the two screws to hold the handle onto the shaft. Adjust the strap on the handle for your own comfort.

Adjusting the Length of the Lower Shaft:

The correct length of the lower shaft should allow you to swing the coil in front of your body without any uncomfortable stretching or stooping.

If the coil is too far from your body it will be difficult to balance and manoeuvre while detecting.

If the coil is too close to your body it may detect your pick, the battery or any other metal which you are carrying, causing confusing sounds.

Rotate the twistlocks of the shafts counter-clockwise to ensure that they are loosened.

Compress the spring pins of the shafts and move them up or down to suit. Once all shafts are clipped into position, rotate twistlocks clockwise onto the shafts until they are firmly clamped.

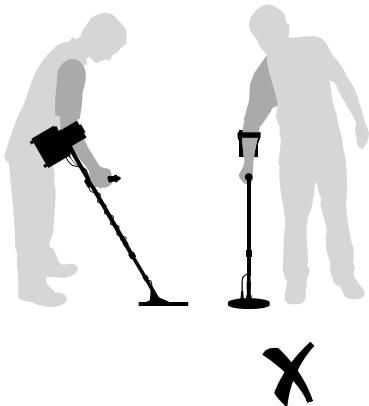

Adjusting the Battery Harness:

A comfortable fitting of the battery harness will ensure the longest detecting session possible, without fatigue.

Ideally, the battery should be placed on your back so that it counter-balances the weight of the detector. You should be able to reach the switches of the detector without putting excess strain on the bungy cord.

Pull the straps outwards and downwards to tighten. Push the straps back through the buckle to loosen.

Adjusting the Bungy Cord Clamp (Bow Knuckle):

The correct position of the bungy cord clamp (bow knuckle) along the shaft can help take the weight of the coil.

Loosen the clamp screw so it can slide along the shaft. Slide it to a position that feels most comfortable for you.

You may need to change the length of the bungy cord or the position of the bungy cord clamp when you change coils or detect on sloping ground.

Caution: Some operators may find it more comfortable to fit the battery around the waist. This is fine, but just make sure that the detector isn't producing a signal from the battery. If using a large coil, have the battery as high up on your back as practical and comfortable to avoid any unwanted interference.



A spare battery is available as an accessory. If travelling into remote areas, a spare battery will ensure you can continue detecting for long periods of time.

The aluminium battery case contains the 7.4V Lithium Ion battery pack and an internal charging circuit. Supplied with the GPX-4000 is a mains charger adaptor and a 12V vehicle charger adaptor.

When fully charged, the battery will provide enough power to operate the detector for 12+ hrs.

The charger will recharge a flat battery in approximately 4 hours. Partially discharged batteries will require a shorter period of time to recharge. There is no need to fully discharge the Li-Ion battery before recharging. The battery may be recharged at any time when not detecting.



Mains Charger Adaptor

The mains charger adaptor will charge the battery from local mains (AC) power outlets.

To Charge with the Mains Charger Adaptor:

- 1 Disconnect the power cable from the battery.
- 2 Connect the mains charger adaptor to the battery power plug and the wall socket.
- 3 Switch the wall socket on.

The colour scheme of the tri-colour LED will indicate the status of the charging process. (pg. 20)

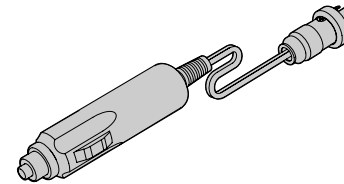

Vehicle Charger Adaptor

The vehicle charger adaptor will charge the battery from the accessories socket (cigarette lighter) of most motor vehicles. The socket must be 12-24VDC.

To prevent damage to the battery, do not start the vehicle while the battery is connected.

Make sure your vehicle battery is in good condition and charged before using it to charge the GPX-4000 battery.

To Charge with the Vehicle Charger Adaptor:

- 1 Disconnect the power cable from the battery.
- 2 Connect the vehicle charger adaptor to the battery and to the vehicle accessories socket.

The colour scheme of the tri-colour LED will indicate the status of the charging process. (pg. 20)

Don't leave the battery on charge in a closed vehicle on a hot day as it is temperature protected and will stop charging.

Routine

Brief cycling red-orange-green:	Occurs once (or a few times) when the detector is turned on or when a new battery is connected
Very brief orange blink:	Beginning of charge
Solid orange:	First phase of charge
Orange with green blink:	Last phase of charge
Solid green:	Battery is charged

Exceptions

Slow orange blinking:	The battery has not been used for a long time and its voltage has dropped below the minimum charge. When the voltage increases the routine battery charge will commence.
Slow red blinking:	The battery is too hot. It has reached a temperature over 60°C and will not charge. Disconnect the battery and wait for it to cool below 40°C in a cool place before reconnecting.
Continuous orange blinking:	The battery has been on charge for too long and will no longer charge. Contact your dealer.
Rapid red-orange blinking:	Output paused while the input voltage is too low.
Solid red:	There is a fault with the battery. Disconnect and reconnect the battery. If the LED is still red, contact your dealer.

Taking Care of Your Battery

The Lithium Ion battery is specifically designed for the GPX-4000.



The Lithium Ion battery is not compatible with previous detectors and for this reason it is supplied with a power lead with non-compatible plugs.

- Do not charge the battery at temperatures above 45°C (113°C).
- Do not charge the battery at temperatures below 0°C (32°F).
- Do not leave the battery in hot conditions (e.g. on the dashboard of your car or rear parcel shelf).
- Do not immerse the battery in any liquid or allow water ingress.
- Do not throw the battery or impact it in any way.
- Do not short-circuit the battery.
- Do not use the battery if it is damaged or deformed.
- Do not disassemble or reconstruct the battery.
- Do not incinerate the battery.

Return the battery to a Minelab authorised service centre for repair. The use of non-approved components will **VOID YOUR WARRANTY**. There are no user serviceable parts within this battery pack.

The GPX-4000 is a 'motion' detector. This means it must be moving over a target to detect it.

The GPX-4000 will perform at its best when the coil is kept close and parallel to the ground at all times. This will increase detection depth and response to small objects.

Practise sweeping the coil over the ground in a side-to-side motion, while walking forward slowly at the end of each sweep. Slightly overlap the previous sweep to ensure full ground coverage. An average sweep speed is four seconds from left to right to left.

A variation in coil height at the end of each swing may cause confusing sounds and reduce detection depth, so an even, flat sweep is desirable.

When using a Monoloop coil, more overlap is required to ensure that targets at maximum depth are not overlooked.

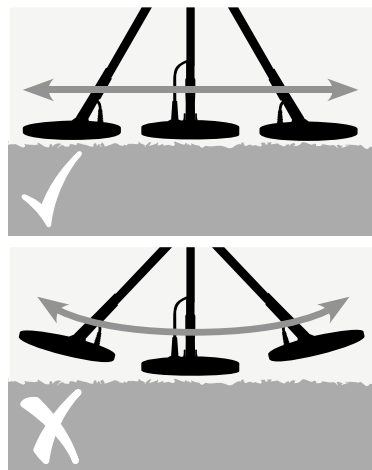
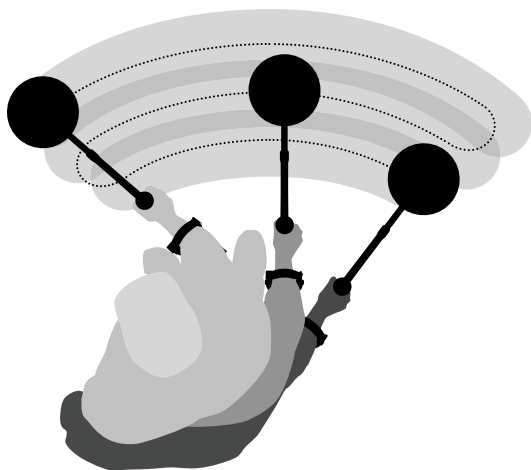

Targets

Buried metal objects are referred to as targets. Targets are comprised of both ferrous and non-ferrous metals.

Threshold (Background sound)

This is the background sound produced by the detector. When a target is detected, the Threshold changes in volume and pitch. Listen to the Threshold carefully. Concentration is an important part of detecting. A very deep or small target may only give a minor change to the Threshold. (pg. 34)

Target Response (Metal Object Response)

This is a change in the tone (pitch) and volume of the Threshold when a target is detected and not discriminated (rejected).

Electrical Interference

The detector may also produce sounds when not over the ground. These will not be target signals, but signals caused from the surrounding environment. The GPX-4000 has a Tune function to overcome electrical interference. (pg. 32)

Ground Noise

The detector may also produce various random signals caused by different minerals in the ground, sometimes referred to as false signals. The GPX-4000 has an automatic Ground Balance function to overcome ground noise. (pg. 38)

Blanking

When sweeping over a rejected target, the Threshold 'blanks' (becomes silent) indicating that a target is located underneath the coil, but has been rejected. Blanking is a useful way of distinguishing between desired and undesired targets. (pg. 59)

Low Battery

When the battery is low, a series of alarm signal pulses are given at 1 minute intervals. (pg. 62)

Auto Tune automatically reduces electrical interference. (pg. 33)

Threshold is the constant background audio produced by the detector. This control increases / decreases the level of the Threshold. (pg. 34)

Coil Connector
Connects the coil to the control box.

Smart Point is a connection point for the Quick-Trak button, located on the handle. Minelab also uses this as a test port to ensure that your detector is operating at peak performance before it leaves the factory.

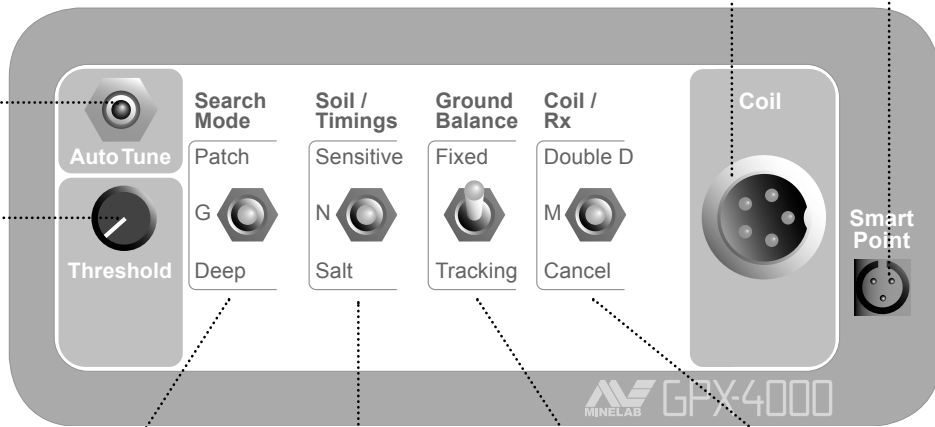

Search Mode
Each Mode has factory preset settings to suit that style of searching. Search Modes can also be customised to suit different detecting conditions. (pg. 28)

Soil/Timings allows you to change the electronic pulses/ timings of the detector to optimise performance for different soils and target types. (pg. 36)

Ground Balance reduces the effect caused by mineralisation in the ground. (pg. 38)

Coil/Rx allows you to change the sensitivity and receive (Rx) fields of the coil. (pg. 44)

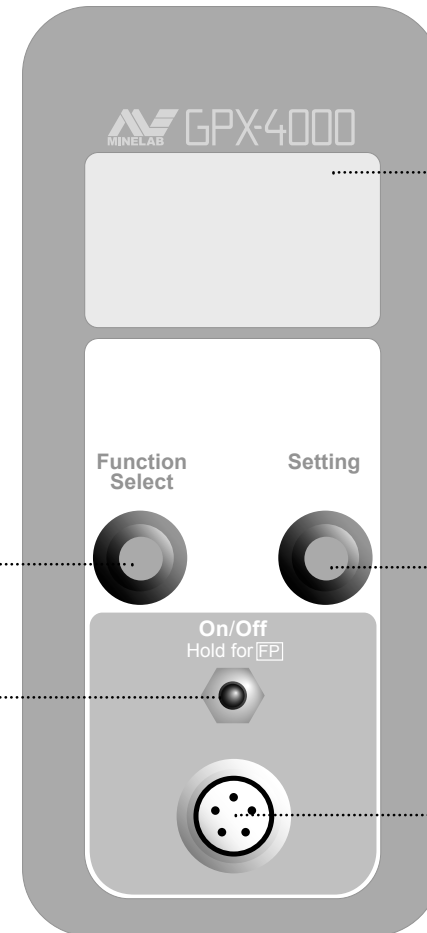

LCD
(Liquid Crystal Display)
Displays all the menu functions and settings.

Function Select scrolls up or down through the list of functions. (pg. 46)

Once a function has been selected, **Setting** allows you to adjust its value. (pg. 47)

On / Off turns the detector on and allows you to restore Factory Presets. (pg. 26)

Battery Connector connects the control box to the battery and headphones.



The On / Off button is located on the back control panel.

To turn the detector on or off:

Press and release On / Off.



It is best to only turn the detector on when outdoors and away from sources of electromagnetic disturbance such as power lines, transmitters, electric fences and phone towers. These sources may cause the detector to perform erratically, giving numerous false signals.

If the detector emits an overload sound, move the coil away from any large metal objects. Overloading is not harmful to the electronics of the detector.

Many of the GPX-4000 functions are accessed through the LCD Menu.

These are explained in further detail throughout the rest of this manual. (pg. 46, 47)

Until you become more familiar with the GPX-4000, the detector can simply be operated with the Factory Presets and the front panel controls.

Functions

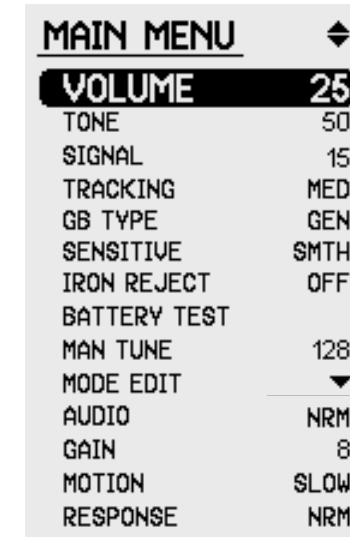

Settings

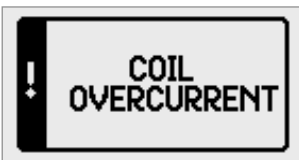
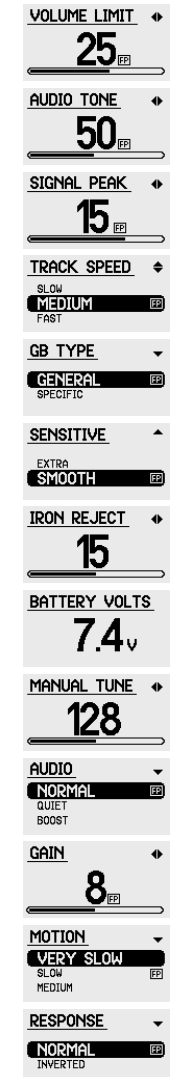

Avoid turning the detector on and off repeatedly. If this happens the Coil Overcurrent screen will appear. Turn the detector off and wait for a short time before turning the detector on again.

Search Mode

Patch



Deep

The GPX-4000 has 3 separate Search Modes: General (G), Patch & Deep. Each Search Mode has a series of Factory Preset settings saved, which can also be customised with personal preferences to suit different detecting conditions.

Selecting the Search Mode

To begin detecting, select the desired Search Mode that best suits the style of detecting you intend on doing. As you switch between Search Modes, the *Main Menu* settings will remain the same while the *Mode Edit* settings will change.

Following is a brief summary of the characteristics of each mode in the Factory Preset settings:



General (G)

The General Mode will provide the best compromise of sensitivity, depth and signal response under a variety of conditions. Until you are comfortable with the different functions and settings of the GPX-4000, General Mode should be used.

Patch



Patch

The Patch Mode can be used when searching new areas. Patch can be used to find the first nugget quickly. You will be able to cover more ground at a faster pace than in General mode. Patch Mode isn't as quiet or stable as either General or Deep, but allows a faster than normal sweep speed and will provide a very sharp target response.

When you want to search the area more thoroughly, change to either General or Deep Mode.



Deep

Deep

The Deep Mode should be used when you are detecting a small area very slowly and carefully, such as when chaining, or when cross-gridding a run of nuggets on a slope. Deep Mode is optimised for a very slow sweep to provide maximum depth, sensitivity, and Threshold stability.

Editing the Mode

When you have tried the different preset Mode options and would like to change some of the settings, you can select your own settings for each Mode via the menu. Scroll down to the Mode functions. Select the function you wish to edit and alter the setting using the Setting control. Any changes made to the settings are automatically saved into the current Mode when the detector is turned off.

The *Main Menu* **MAIN MENU** ▾

functions are the same for each Search Mode.

VOLUME	25
tone	50
SIGNAL	15
TRACKING	MED
GB TYPE	GEN
SENSITIVE	SMTH
IRON REJECT	OFF
BATTERY TEST	
MAN TUNE	128

The *Mode Edit* **MODE EDIT** ▾

functions can be saved with different settings for each Search Mode.

GENERAL MODE ▾	MODE EDIT ▾	MODE EDIT ▾
AUDIO NRM	PATCH MODE ▾	DEEP MODE ▾
GAIN 8	AUDIO BOOST 7	AUDIO DEEP
MOTION SLOW	GAIN 7	GAIN 9
RESPONSE NRM	MOTION MED	MOTION V SLOW
	RESPONSE NRM	RESPONSE INV



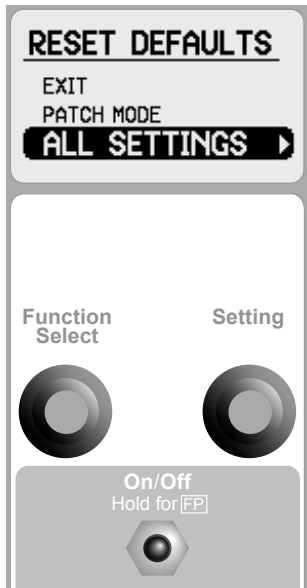

The GPX-4000 is provided with a Factory Preset FP selection of menu settings, suitable for first-time users.

Until you become more familiar with the GPX-4000, the detector can simply be operated with the Factory Presets and the front panel controls.

To restore all Factory Preset settings:

- 1 Turn the detector off.
- 2 Press and hold On/ Off until the Reset Defaults menu appears (approx. 5-6 seconds).
- 3 Turn Function Select to the right to select All Settings, as shown on the diagram.
- 4 Turn Setting left or right to restore all Factory Presets.

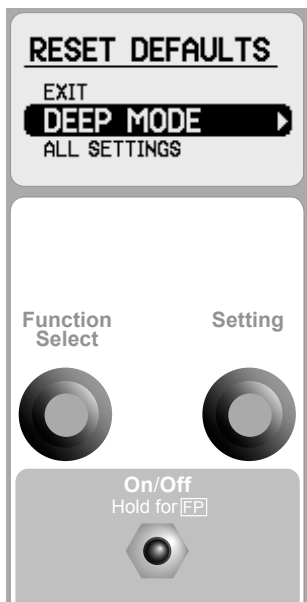

To restore Factory Preset settings for the current search mode:

- 1 Turn the detector off.
- 2 Press and hold On/ Off until the Reset Defaults menu appears (approx. 5-6 seconds).
- 3 Turn Function Select to the right to select the current mode. The current mode is dependent on the mode switch on the front panel. *Note: If the displayed mode is not the one you wish to restore you must change the mode on the front panel.*
- 4 Turn Setting left or right to restore Factory Preset settings for that mode.

Main Menu:	Range:	Factory Preset:		
Volume Limit	1 to 40	25		
Audio Tone	1 to 100	50		
Signal Peak	1 to 20	15		
Track Speed	Slow Medium Fast	Medium		
GB Type	General Specific	General		
Sensitive	Extra Smooth	Smooth		
Iron Reject	Off (All Metal) 1 to 30	Off (All Metal)		
Battery Volts	-	-		
Manual Tune	0 to 255	-		
Mode Edit:		General:	Patch:	Deep:
Audio	Quiet Normal Boost Deep	Normal	Boost	Deep
Gain	1 to 15	8	7	9
Motion	Very Slow Slow Medium Fast	Slow	Medium	Very Slow
Response	Normal, Inverted	Normal	Normal	Inverted

Reducing Electrical Interference



If you would like to know what channel has been chosen after an automatic Tune, access the Manual Tune screen and check the channel displayed.

The detector may become noisy due to electrical interference from powerlines, radio transmitters electrical equipment or other detectors operating close by. The detector interprets this interference by the Threshold becoming erratic.

So that the detector experiences the least interference for the current environment, the search channel can be changed automatically by the Auto Tune button on the control panel, or manually in the Manual Tune setting via the menu. (pg. 63)

Auto Tune instructs the detector to automatically listen to every channel and select the quietest channel. Automatic tuning may take up to 60 seconds.

The Manual Tune setting, via the main menu, allows you to manually select and listen to every channel for the least interference.

The best channel to select will be the one where the audio response to electromagnetic disturbances (e.g. powerlines) is the most reduced.

It is best to select a channel with the coil away from the ground and as still as possible. This gives the detector the best chance of hearing all surrounding interference (not from the ground or targets) and selecting the quietest channel.

Interference in some locations can change during the course of the day so you may need to re-tune from time to time to maintain a smooth Threshold as you move around the area.

Note: There is only one Tune setting. Any changes made manually will override the Auto selection.

Tuning should be done initially with the Coil switch in Double-D or in Monoloop (M). If the interference is still severe after completing the tuning operation, change the Coil switch to Cancel and only re-tune the detector again if necessary.

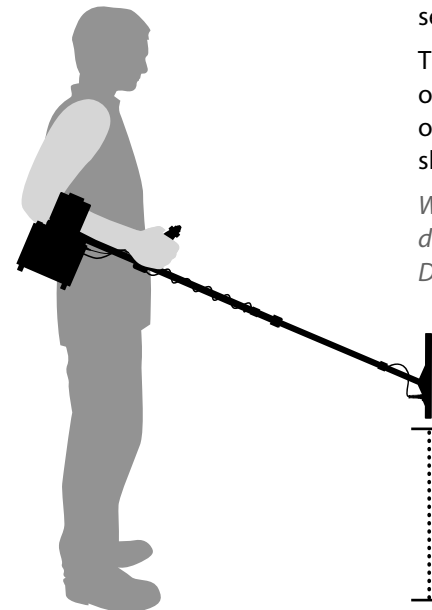

To Perform an Automatic Tune:

- 1 Hold the detector at waist height and the coil vertical and slowly rotate through a half-circle, making sure there are no large targets or obvious electrical interference sources close by. Listen for any increase in interference as you move.

Note: If you have difficulty holding the detector very still for 60 seconds, you can place the detector on the ground with the coil vertical.

- 2 Press the Auto Tune button. Keep the detector completely still during the automatic channel selection.

A single beep indicates the beginning of the Auto Tune. The detector will begin to scan each channel for the least interference. This may take up to 60 seconds.

The detector will then select the quietest operating channel that was identified. The end of the Tuning process will be indicated by three sharp 'beeps'.

When tuning the detector in close proximity to other detectors, each operator needs to take turns tuning. Do not try to tune two detectors at the same time.

If Auto Tune is not working well in Slow or Very Slow Motion, try selecting Medium setting. Perform another Auto Tune and then return to the original setting.

34 Threshold

Adjusting the Background Audio Level



Threshold is the constant audible background audio tone or 'hum' produced by the detector.

The level of the Threshold should be set low, but still audible and stable. Ideally it should be a smooth, gentle hum.

Small targets or large deep targets may not produce a distinct target signal, but may cause only a small variation in the Threshold.

If the Threshold level is set too high or too low, these very small variations may be missed.

Listening for a target signal with a high Threshold would be like trying to hear a whisper within a crowded noisy room. A high Threshold volume may also be uncomfortable for your hearing.

If the Threshold is set too low, the target signal needs to be loud enough to become audible, therefore very soft target signals from small or very deep targets may not be heard.

It is important to reset the Threshold level as conditions change. For example, your ears may adjust to the low levels of audio after an hour or so, or the conditions may have become windy.

When the Threshold is too high, a faint signal is masked, and only the peak of the loud signal is audible above the Threshold.

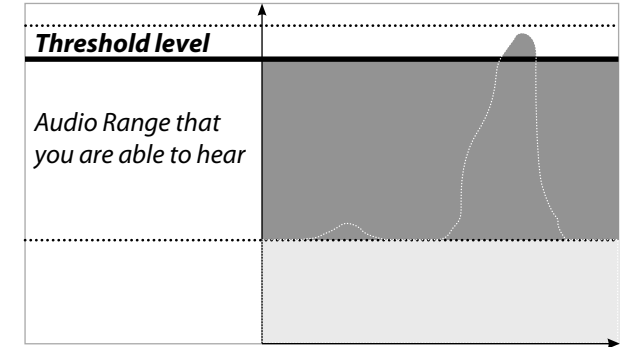

With the Threshold set correctly, both target signals are easily heard.

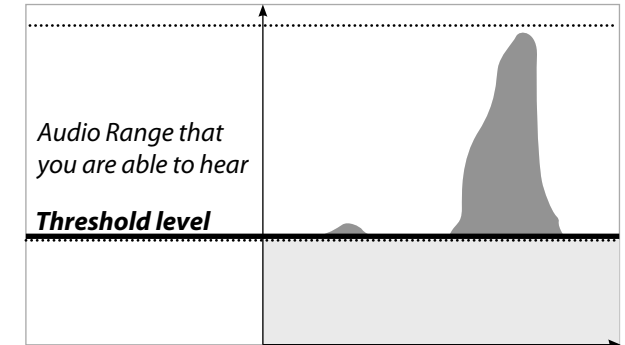

A Threshold level that is too low does not allow faint target signals to be heard.

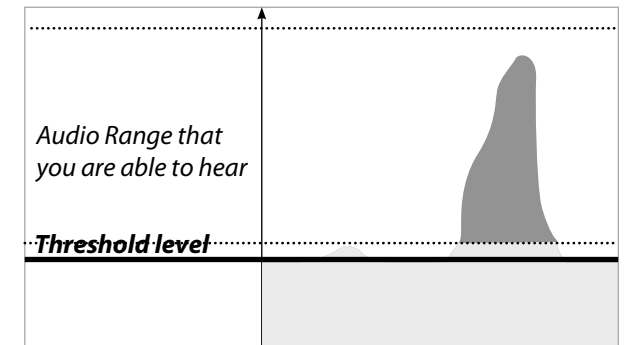

Soil/Timings

Optimising the Detector for Different Soil and Target Types

Soil / Timings

Sensitive



Salt

The Soil/Timings switch has the ability to change the electronic 'timing' or pattern of the pulses. This optimises the detector for different soil conditions, the type of coil being used and desired target sizes. Soil/Timings can make a big improvement to your finds.

Put simply, certain combinations of pulse patterns (timings) have a particular affinity to certain soil conditions, (be it magnetic/alkaline/neutral, etc.) and on different target sizes and conductivities. By using the Soil/Timings switch, changes to the timings can be made to improve the performance in different conditions.

Sensitive



Sensitive

Sensitive timings have been optimised for an improved response on smaller, shallow nuggets. There is a slight loss of depth on bigger targets, so you should not use this setting when seeking out large deep nuggets.

There are two types of Sensitive settings available via the LCD, Extra and Smooth (pg. 55). Smooth is the factory Preset setting and is very different to previous GP models. It will eliminate most false signals from hot rocks and ground mineralisation whilst retaining excellent sensitivity to small targets.

When switching between Soil/Timings, there is a 1 second pause (ie. 1 second of Threshold) to allow the change in the detectors electronics to take effect.



Normal (N)

Normal gives you the best performance on a wide range of soil conditions and will provide the best depth on a wide variety of target sizes. You will use this setting most of the time. You should always use Normal in new areas where you are unsure of the soil mineralisation and the depth of targets.

Salt

The effect of alkaline salt mineralisation is vastly different to the effect of ironstone and mineralised clays. Anyone who operates on dry salt flats will know how difficult it is to detect. In these areas, Normal should be tried first, but if the Threshold is too unstable, then better performance will be obtained in Salt.

Using the Salt setting may result in a slight loss in signal response to smaller targets. The response on larger items remains relatively unaffected and ground noise is usually minimised. Therefore, when searching for large deep nuggets in highly mineralised soil, the Salt setting can be used to obtain a smoother Threshold, allowing you to hear those mellow deep nugget signals.



Salt



Always remember to re-Ground Balance the detector after making any changes to the Soil/Timings switch.

Ground Balance

Fixed



Tracking

The ground contains not only sand, but also many different chemicals, minerals and salts. These extra materials are referred to as ground mineralisation. This ground mineralisation may often produce erratic sounds, known as 'ground noise'.

The Ground Balance function minimises the ground noise while retaining maximum sensitivity to metal targets. Ground Balancing the detector ensures that signals from targets, such as gold nuggets, are not confused with interfering ground noises.

The GPX-4000 has the ability to cancel out the effects of ground mineralisation automatically, and the Tracking function will maintain a perfect Ground Balance while you search.



Tracking

Tracking

Tracking instructs the detector to test for changes in ground mineralisation and will automatically adjust the Ground Balance setting, when necessary, during detecting.

Tracking is preferred in heavily mineralised ground, especially where the mineralisation is changeable, or when you want to cover a large area quickly and efficiently.

Fixed



Fixed

Fixed holds the last Ground Balance setting. In ground where conditions allow, Fixed will provide greater depth, sensitivity and sharper target signals, provided that a perfect Ground Balance is maintained.

Fixed will give slightly improved performance but will require re-balancing when necessary. Using the Quick-Trak button is an easy way to do this. (pg. 43)

Where possible, always search in Fixed position to maximise depth and sensitivity, and only use Tracking in areas with excessive ground noise and/or rapidly changing mineralisation.

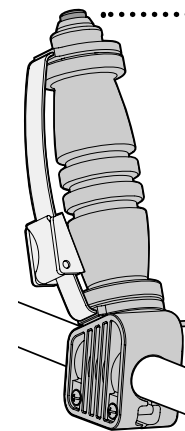

Quick-Trak Button

The Quick-Trak button found on the handle assembly allows you to temporarily switch between Fixed and Tracking, or vice versa.

The Quick-Trak button only changes the Ground Balance position (Fixed or Tracking) while the button is pressed. Once the button is released, the Ground Balance setting returns to the switch position selected on the front control panel.

The Quick-Trak button will most commonly be used to Ground Balance the detector and also to fix or hold the Ground Balance setting while pinpointing. (pg. 43)

40 Ground Balance Procedure for Tracking

(For Ground Balance Type – General)

- 1 Find a clear area of ground without any targets.
- 2 Change the Ground Balance switch to Fixed.
- 3 Whilst keeping the coil parallel to the ground, lower and raise the coil between 25mm and 100mm (1" and 4") over the ground. Try to lower the coil as close to the ground as possible without touching it.
- 4 While moving the coil (*see note*), change the Ground Balance switch to Tracking and continue moving the coil up and down until the audio has stabilised and any ground noise has stopped.

A persistent signal may indicate a target in the ground. If this occurs, then move the coil to a new location and repeat the procedure.

- 5 When there is no longer a change in the Threshold, the detector is 'Ground Balanced', and you can commence detecting.

Note: When changing the Ground Balance switch from Fixed to Tracking, a very fast auto-Ground Balance is initiated prior to returning to a normal Tracking speed. This fast Ground Balance only lasts a short time, so it is important to be moving the coil before attempting to ground-balance.

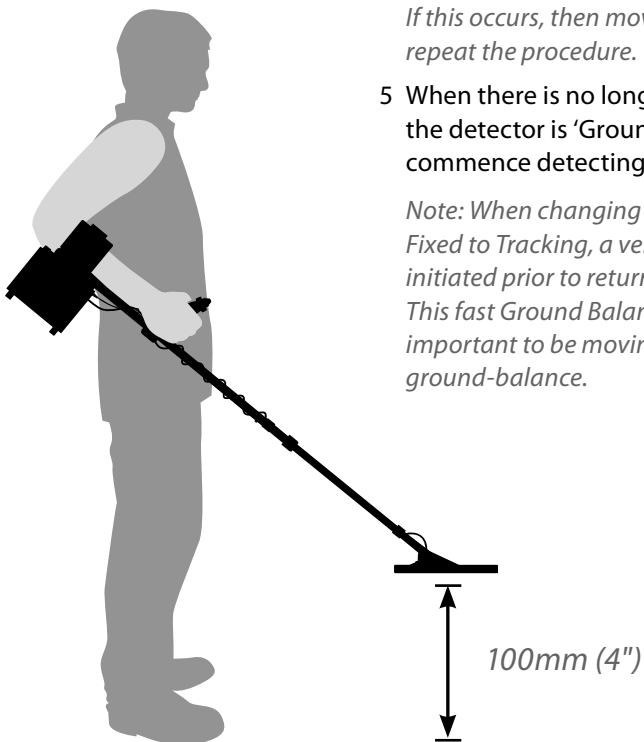

Ground Balance re-set in Tracking

Whilst sweeping the coil, you can test if you are still in harmony with the ground by stopping, and raising and lowering the coil – if the Threshold remains stable then you are still Ground Balanced. If there is a change in the Threshold, then you need to re-set the Ground Balance setting.

While moving the coil, press and release the Quick-Trak button. A short 'beep' will be heard which lets you know that a 3 second fast auto-Ground Balance is initiated prior to returning to Tracking. Once the audio has stabilised, you can continue searching.

If you find that the Ground Balance needs to be re-set quite regularly, you can select a Faster Tracking speed. (pg. 54)

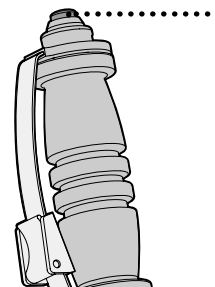

As Tracking continually updates the Ground Balance setting automatically, repeated passes over a target may result in the detector balancing to the target instead of the ground, diminishing the target signal and increasing ground noise.

Therefore, it is important to use Fixed when pinpointing or when investigating a potential faint signal with repeated sweeps.

42 Ground Balance Procedure for Fixed

(For Ground Balance Type – General)

Fixed



- 1 Find a clear area of ground without any targets.
- 2 Change the Ground Balance switch to Fixed.
- 3 Whilst keeping the coil parallel to the ground, lower and raise the coil between 25mm and 100mm (1" and 4") over the ground. Try to lower the coil as close to the ground as possible without touching it.
- 4 While moving the coil, press and hold the Quick-Trak button. The Tracking program initiates a very fast Ground Balance for a short time. This is the same effect as changing the Ground Balance switch to Tracking on the front panel.
- 5 Continue moving the coil up and down until the ground noise has stopped. When there is no longer a change in the Threshold, the detector is 'Ground Balanced'.
A persistent signal may indicate a target in the ground. If this occurs, then move the coil to a new location and repeat the procedure.
- 6 Release the Quick-Trak button to return to the Fixed position and commence detecting.

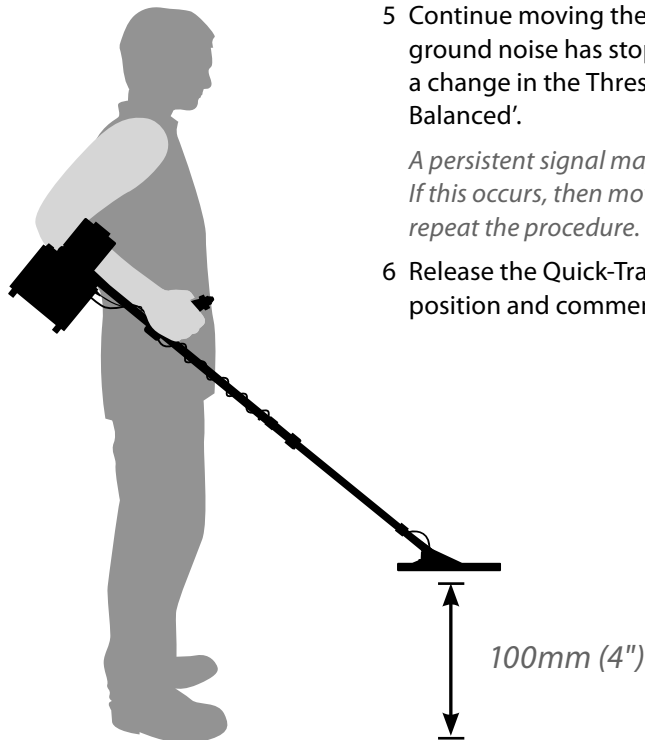

It is very important when searching with a Fixed Ground Balance, that the Ground Balance setting is regularly checked and maintained. Testing by raising & lowering the coil is quick and simple and should become a regular part of your detecting technique.

Ground Balance re-set in Fixed

Whilst sweeping the coil, test if you are still in harmony with the ground by stopping, and raising and lowering the coil. If the Threshold remains stable then you are still Ground Balanced. If there is a change in the Threshold, then you need to re-set the Ground Balance setting.

This is achieved by simply repeating steps 3-6 of the Ground Balance procedure for Fixed.

Ground Balancing Tips

When going over old patches, i.e. small concentrated areas known to have produced gold nuggets, run in Fixed Ground Balance and periodically re-Ground Balance with the Quick-Trak button every few metres.

When Ground Balancing in very rocky terrain, lower the coil to the height above the ground that you will actually be swinging it at.

In highly magnetic soils, you may have trouble ground balancing the coil all the way to the ground (most common with larger Monoloop coils). If you experience this, you can change the Ground Balance type to Specific. (pg 56)

Changing the Sensitivity and Receive (Rx) Fields of the Coil

Coil / Rx

Double D



Cancel

Coil/Rx allows you to change the sensitivity and search patterns of receive (Rx) fields of the coil.

The GP series or Commander Range of Double-D coils can change characteristics to suit different detecting conditions and targets.

Coils not specifically designed for the GPX-4000 may behave erratically or be ineffective in either Monoloop (M) or Cancel.

It is very important that you always switch off the detector before changing coils.

You will need to re-Ground Balance every time you select a new position for the 'Coil' switch.

Double D



Double-D

This is the most suitable electromagnetic field for areas of medium to very high mineralisation. It is also excellent for pinpointing as the target response is strongest from the centre of the coil.

The search pattern of this position is the conventional blade or wedge shaped signal through the centre of the coil.



Minelab Monoloop coils can be used on the GPX-4000 with excellent results. We recommend their use in conjunction with the Coil/Rx switch in Monoloop (M).

Monoloop (M)

This setting may be used in most locations of low to medium mineralisation. Monoloop is also suitable for locating small nuggets with Soil/Timings switch set to Sensitive.

Use of Monoloop will often increase the sensitivity of the detector but may also be a little more unstable in heavily mineralised ground. Pinpointing is not centred in the middle of the coil, but to the left side and may give a complex signal when the target is very close to the coil, so it is recommended to use the left edge of the coil to pinpoint shallow targets.



Cancel

Salty Environments: In highly saturated salt conditions such as ocean beaches or large inland salt lakes, the use of Cancel may give better performance than Salt. As a general performance comparison, Cancel will be more sensitive, but Salt has a greater depth potential on larger targets.

Cancel

This setting provides a receive field that is particularly stable in areas of electrical interference. This position is ideal for detecting close to neighbourhoods or where the Tune function has difficulty selecting a quiet operational channel (e.g. near power lines, phone towers or under poor atmospheric conditions).

Pinpoint in Cancel will be to the left side of centre and signals may be complex if the target is close to the coil. In Cancel, Sensitivity and depth are slightly reduced.

Tip: You may be able to increase Gain if using Cancel. (pg. 65)

Transmit
Receive

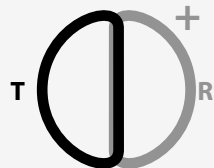

Double D

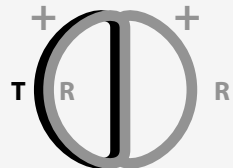

Monoloop

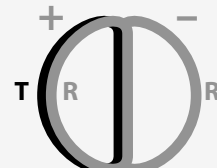

Cancel



The detector will not detect targets if Cancel is used with a Monoloop coil.

The **Function Select** control scrolls through a list of functions.

Title
indicates what type of function you are viewing (general or mode dependant).

Functions
There are two types of functions, general functions (under the *Main Menu* heading) and mode dependant functions (under the *Mode Edit* heading).

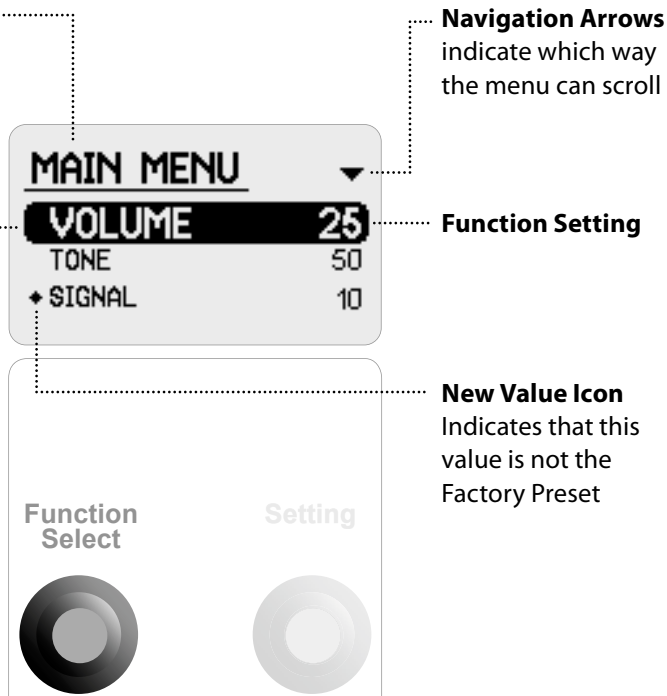

Once a function has been selected, the **Setting** control accesses a settings adjustment screen.

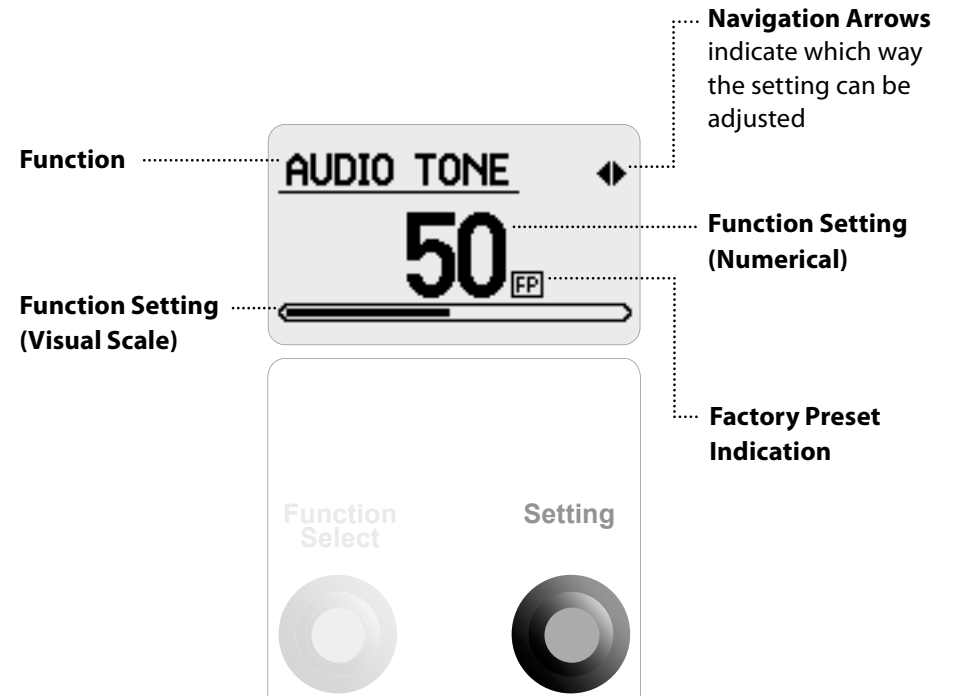

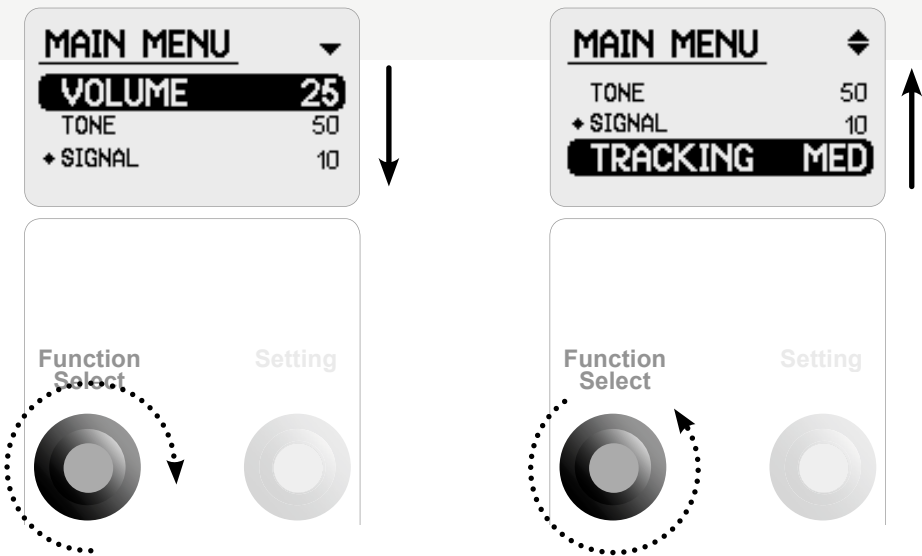

Turn the **Function Select** control right to scroll down the list. The currently selected function is highlighted.

Turn the **Function Select** control left to scroll up the list. The currently selected function is highlighted.

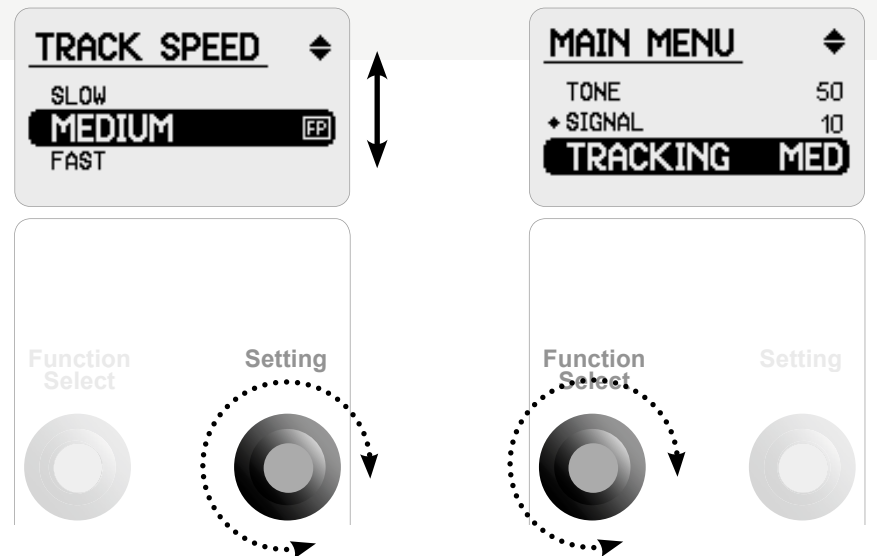

With a function highlighted, turn the **Setting** control to the left or right to adjust the setting.

To return to the list of functions, turn the **Function Select** control left or right.

The *Main Menu* **MAIN MENU** ▾

VOLUME	25
TONE	50
SIGNAL	15
TRACKING	MED
GB TYPE	GEN
SENSITIVE	SMTH
IRON REJECT	OFF
BATTERY TEST	
MAN TUNE	128

The *Mode Edit* **MODE EDIT** ▾

GENERAL MODE	MODE EDIT	DEEP MODE	
AUDIO	BOOST	AUDIO	
GAIN	8	GAIN	9
MOTION	SLOW	MOTION	V SLOW
RESPONSE	NRM	RESPONSE	INV

G Patch Deep

Note: The Battery Test screen will automatically return to the list of functions after 7 seconds.

Volume Limit

Setting the Maximum Volume of all Sounds

Range | **1 to 40**
Factory Preset | **25**

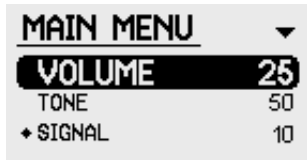

Volume Limit is the maximum level of sound emitted by the detector when a target is detected.

If the Volume is set to maximum, all target signals will be heard and will sound proportional to the target size and depth. Maximum limit allows you to hear the difference between a small and large target, but may be uncomfortable to your hearing if a large target is found close to the coil.

If the Volume is set to half-way the target signal is unaffected for a small target, but is limited for a very large target.

If the Volume is set to minimum, most targets will potentially be very limited. A low volume will be more comfortable on your hearing, but will increase the risk of missing small targets.

Try using a large and small target to adjust the Volume to a comfortable level.

Threshold should be reset after adjusting the Volume level.



The detector is able to produce an extremely high volume if a large or shallow target is located.

Protect your ears!

*Maximum Volume Limit:
Faint and loud signals are unaffected.*

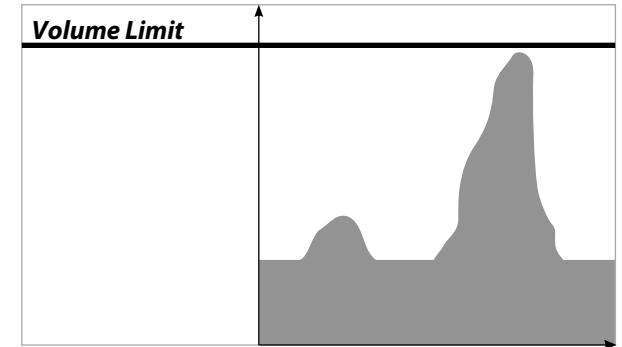

*Mid-Range Volume Limit:
Faint Signals are unaffected, but loud signals are limited.*

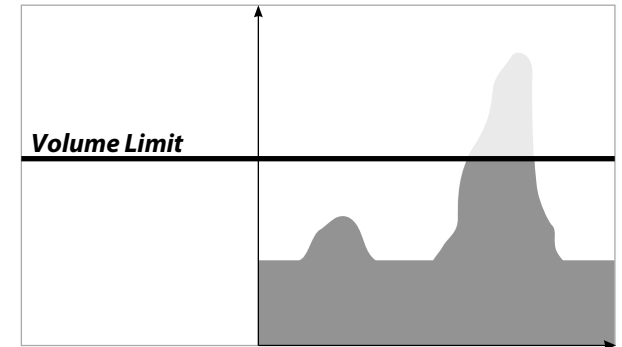

*Minimum Volume Limit:
Both loud and faint signals are reduced to quiet levels.*

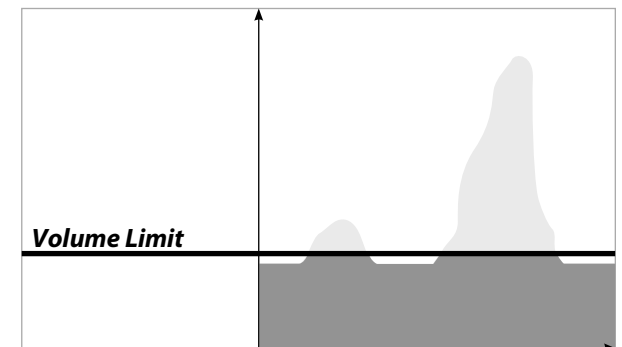

Audio Tone

Adjusting the Pitch of the Threshold of the Threshold

Range | 1 to 100
Factory Preset | 50

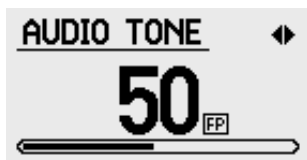
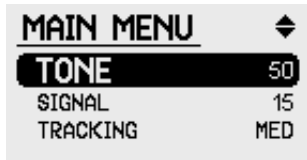

Tone is the pitch of the Threshold emitted by the detector.

Large, deep targets produce a different response to small shallow targets. It is important that you adjust the Tone to suit the type of target you are searching for.

A high Tone setting may help identify ground signals from small targets. A low Tone setting may be more comfortable on your ears.

Tone is also a personal preference. You may find that you hear targets better in a particular range of Tone.

Try using a large and small target to adjust the Tone to produce the most audible target signal for your hearing.

Signal Peak

Adjusting the Pitch Variation of Target Signals of Target Signals

Range | 1 to 20
Factory Preset | 15



You are more likely to hear a target signal when both the volume and the tone of the target signal change upon detection rather than the volume alone.

A target signal on the GPX-4000 is normally a two-tone signal. A target signal that first falls in pitch and then rises is normally a deep target. A 'rise and fall' of the pitch characterises a small target.

The Signal Peak control sets the level of variance between the high and low pitch of the signal.

A **high** Signal setting will increase the pitch variation of the target signal, however in highly mineralised ground this high variance of signal may make the detector appear noisy.

A **low** Signal setting will decrease the pitch variation, so target signals will sound more monotone.

People who suffer high frequency hearing loss may prefer to use a Signal Peak setting of 10 or less.

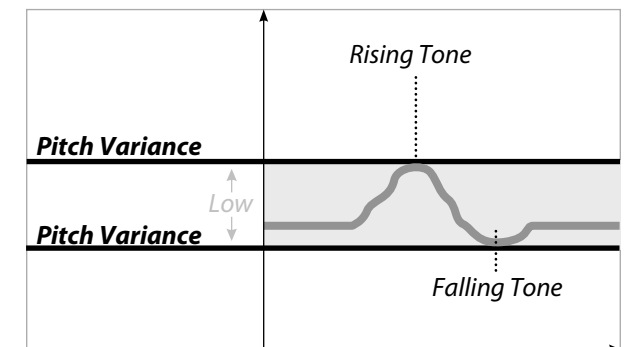
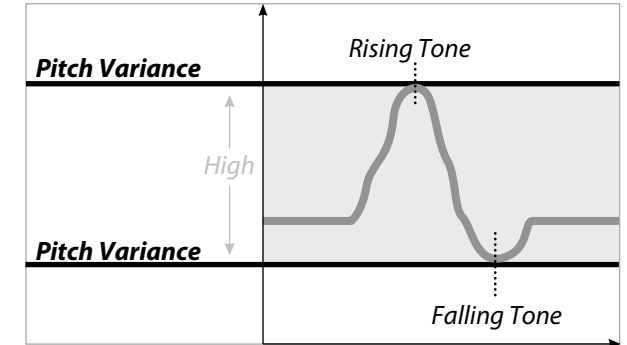

Tracking Speed

Keeping up with Changing Ground

(Ground Balance, pg. 40)

Range
Factory Preset

Slow, Medium, Fast
Medium



When searching in highly variable mineralisation, Tracking Ground Balance is the preferred setting. Tracking Ground Balance automatically adjusts the Ground Balance as necessary to maintain stability and detection depth.

The GPX-4000 has three Auto Tracking Speed options: Slow, Medium & Fast.

If the ground being detected has mineralisation which is changing too often for you to search in Fixed, then Tracking Speed allows you to gradually increase from Slow Tracking Speed, into Medium Tracking Speed, then into Fast Tracking Speed, as required.

The preferred Tracking Speed is the slowest speed which still keeps up with the variability of the ground mineralisation.

In ground conditions that make operating in Fixed impractical, the factory preset Medium setting provides a good compromise between effectively maintaining the Ground Balance and pausing the Ground Balance when a target is located.

Coils with Tracking

The Fast Tracking Speed is very effective at adjusting the Ground Balance in highly variable soils. Its use will only be required in extreme cases.

When using a Monoloop coil, the nature of the Tracking tends to be more aggressive. Faint, deep targets may be 'tracked out'. In these extreme, highly variable soil types, you may achieve better performance by opting to use a Double D coil instead of a Monoloop and then selecting the most appropriate Tracking Speed.

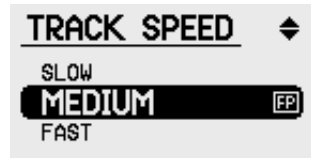

Initial Very Fast Ground Balance

Every time you switch from Fixed to Tracking on the front control panel or via the Quick-Trak button, the GPX-4000 will initiate a very fast auto Ground Balance. The Tracking Speed does not affect the speed of the initial very fast auto Ground Balance.

Sensitive Soil/Timings

Range
Factory Preset

Smooth, Extra
Smooth

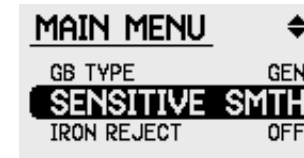

The GPX-4000 offers two separate Sensitive Soil/Timings options - Smooth and Extra.

The Sensitive timing found on previous GP series detectors is now called Extra, and provides an increase in signal response and depth on smaller targets where ground conditions allow it to be used effectively.

In milder ground conditions, with minimal ground signals, the Sensitive Extra setting is the preferred option, however Minelab recommends new users to first become familiar with the GPX-4000 using the Factory Preset Smooth setting.

Extra

This setting may increase the signal from certain hot rocks near the surface, but can actually help smooth out the Threshold in certain ground types, particularly with Double-D coils. In mild ground conditions, Extra will provide the best signal response on a small, deep target.

Smooth

The all-new Smooth option is the Factory Preset setting for Sensitive. It is a radically different timing that sacrifices some depth, but does an excellent job at eliminating most signals from hot rocks and ground noises. Highly mineralised areas that produced small and relatively shallow nuggets, are well worth another search, particularly those areas where a Monoloop coil was previously unusable.

The Smooth option can work well in combination with the factory preset Patch Mode (pg. 28), particularly when you are after the smallest bit of gold, to let you know you are in the right area.

Range
Factory Preset

Specific, General
General

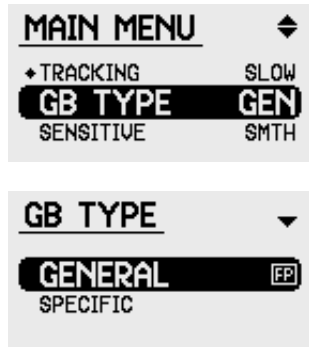

General

This is the best Ground Balance Type for use in over 90% of goldfield soils and uses the conventional automatic Tracking on the previous Minelab model, the GP3500. In Tracking, General Ground Balance samples variations in the ground mineralisation and sets a continuously changing average of the Ground Balance level. General Ground Balance is ideal for most mineralised grounds and is the preferred Ground Balance Type for soils that have highly variable mineralisation.

Specific

This is a special Ground Balance Type for use in areas of highly magnetic, iron-rich soils. Use of Specific Ground Balance will allow you to keep the coil closer to the ground and allows Monoloop coils to be accurately Ground Balanced in areas that would normally be too 'hot' for their use. The Tracking function in Specific is more conservative than in General, and will pause on even the faintest response, removing the risk of 'Tracking out' faint signals.

The disadvantage of using Specific is the possibility of more ground noise in variable soils. It is recommended that the operator be more active in checking their Ground Balance setting by stopping periodically and raising and lowering their coil, and listening to any variations. Ideally, Specific Ground Balance should only be used in soils that are reasonably uniform or non-variable.

When moving to a new area, the first Specific Ground Balance must be done with the Ground Balance switch – not the Quick-Track button.

- 1 Find a clear area of ground without any targets.
- 2 Change Ground Balance to Fixed.
- 3 Hold the coil 300mm–450mm (12"–18") above the ground.
- 4 Change the Ground Balance switch to Tracking. You will hear a high pitched Threshold that only lasts 1 second.
- 5 When the low pitch tone begins, immediately start lowering and raising the coil over the ground. Try to lower the coil parallel and as close to the ground as possible without touching it.
- 6 Continue moving the coil up and down until the audio has stabilised and any ground noise has stopped. When there is no longer a change in the Threshold, the detector is 'Ground Balanced'.
- 7 Change the Ground Balance back to Fixed and commence detecting.

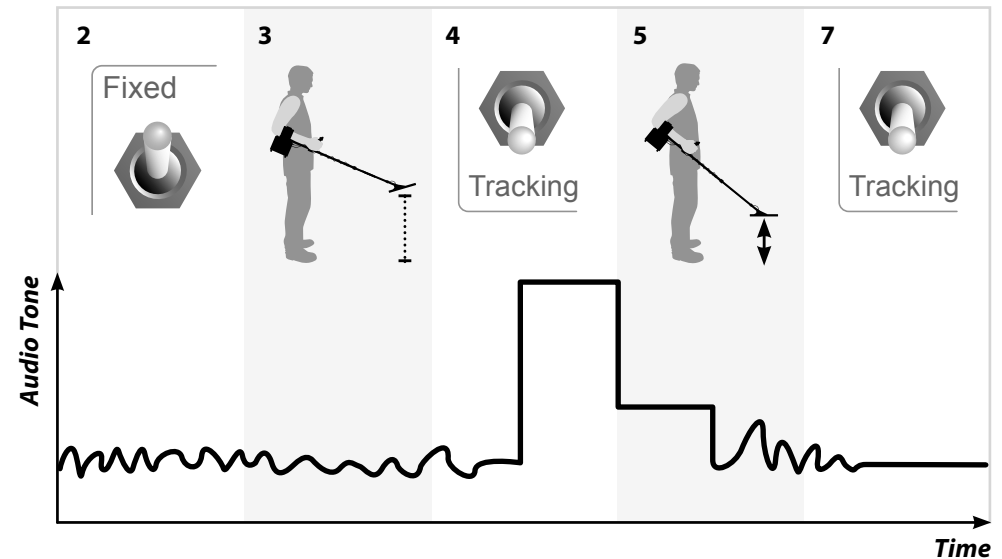

Accepting all Targets Types

Range | **Off (All Metal), 1 to 30**
 Factory Preset | **Off (All Metal)**

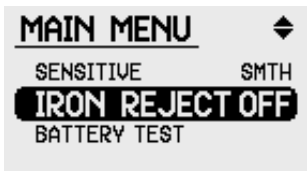

The GPX-4000 is capable of rejecting many iron/ferrous targets while still detecting non-ferrous targets.

While detecting in littered goldfields, much of the iron rubbish may be ignored, with a high probability that valuable targets will not be missed.

When Iron Reject is turned off, no iron targets will be rejected, therefore all types of metals will produce a target response. This is known as 'All Metal' and is the preferred setting for most situations.

In All Metal, the detector will give varying volume and pitch signals. This information does not indicate the type of metal in the object.

If Pinpointing a target prior to digging, best results will be obtained from turning Iron Reject Off.

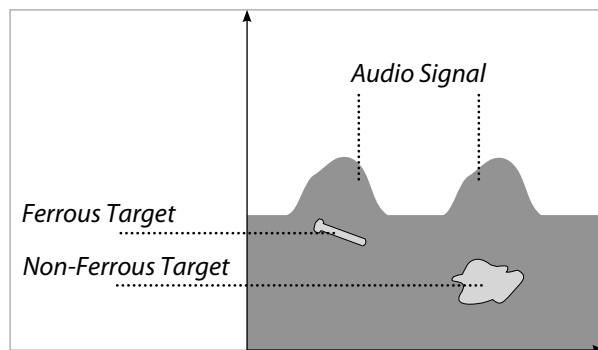

All Metal

When a target has been located, the coil should be passed back and forth over the target centre several times. Remember to set Ground Balance to Fixed for this and keep the sweep across the target at an even height and as close to the ground as possible.

For deep targets, the hole being dug may not be wide enough for the coil to move sideways across the target. Therefore the discrimination may not be accurate. You should always test the target from at least two directions (90° to each other) so that the detector 'sees' the target from different profiles.

When Iron Reject is activated, iron or ferrous objects are rejected by blanking the normal target signal, so that the Threshold Tone goes silent as the coil passes across the target.

Discrimination is dependent on target signals being strong enough for the GPX-4000 to determine if the target is ferrous or non-ferrous. If the signal is weak, the detector will give a non-ferrous response until the signal becomes stronger due to a hole being dug and the coil getting closer to the target. The Iron Reject function is designed this way for maximum accuracy.

Caution: Do not attempt to discriminate by raising and lowering the coil on a deep or partially dug target. An accurate discrimination requires an even side-to-side coil motion.

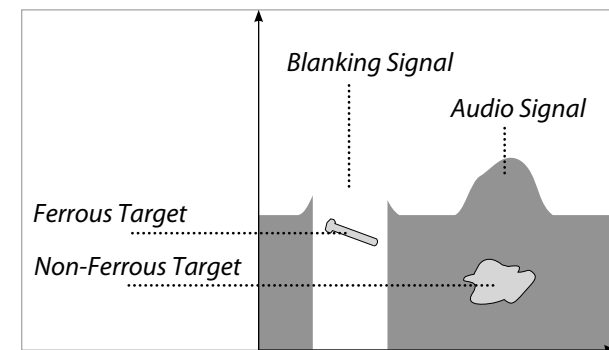

Discrimination / Blanking

Iron Reject

Rejecting Iron Targets

Range | **Off (All Metal), 1 to 30**
Factory Preset | **Off (All Metal)**

There is usually some merging of characteristics between targets that are clearly ferrous and others that are 'maybe' ferrous. Iron Reject allows you to make fine adjustments in the determination of the 'maybe' signals.

Iron Reject will give the best results when used in combination with the specially designed GP Series or Commander Double-D coils and will not work when using Monoloop coils.

A low level of Iron Reject requires a stronger ferrous signal before discrimination occurs. A high level of Iron Reject will cause blanking on a smaller ferrous targets. Very weak ferrous target responses will give normal 'all metal' type signals.

Select the level of Iron Reject depending on how cautious you want to be and how much trash is in the area.

If the area is heavily littered, you may want to use a higher level of Iron Reject. If there is little trash in the area and it is mostly close to the surface you may prefer a more conservative, low level of Iron Reject.

It is usually best to recover all targets, especially when you are on a known gold producing site or a successful patch. However, careful use of the Iron Reject feature can be rewarding in areas other operators have avoided.

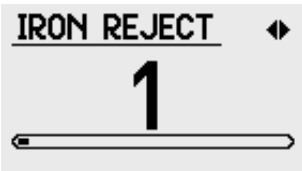

A low level of Iron Reject will keep the discrimination conservative. 'Maybe' targets will respond with a normal non-ferrous signal and only definite ferrous targets will cause the Threshold and target signal to blank. If the target response is too weak for accurate discrimination, the detector will give a normal target signal until you dig closer to the target and the signal strength improves.

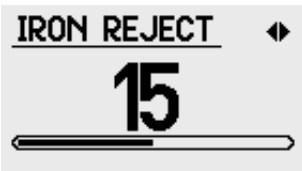

A medium level of Iron Reject is a little less conservative and will enable you to reject most ferrous targets from the non-ferrous targets.



A high level of Iron Reject will be less conservative again and more 'maybe' targets may be rejected as ferrous targets, therefore giving a blanking signal. With this setting some small non-ferrous targets, e.g. gold coated ironstone could be mistaken for ferrous targets.

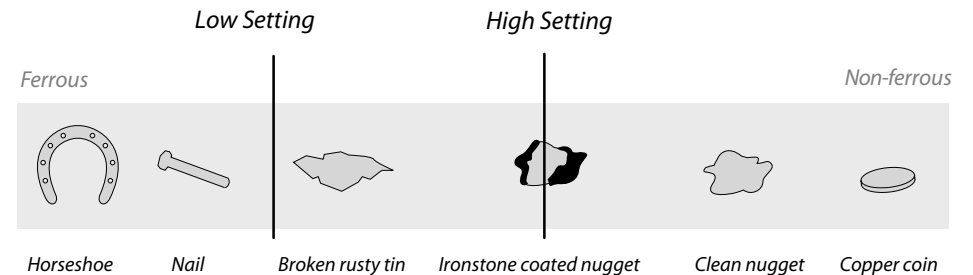

62 Battery Test

Viewing the Battery Voltage



The Battery Volts screen allows you to view the current voltage of the battery. This screen can be viewed at any time.

When the battery is low, a series of alarm signal pulses are given at 1 minute intervals.

Note: The Battery Volts screen will display for a short time and then the menu will automatically return.

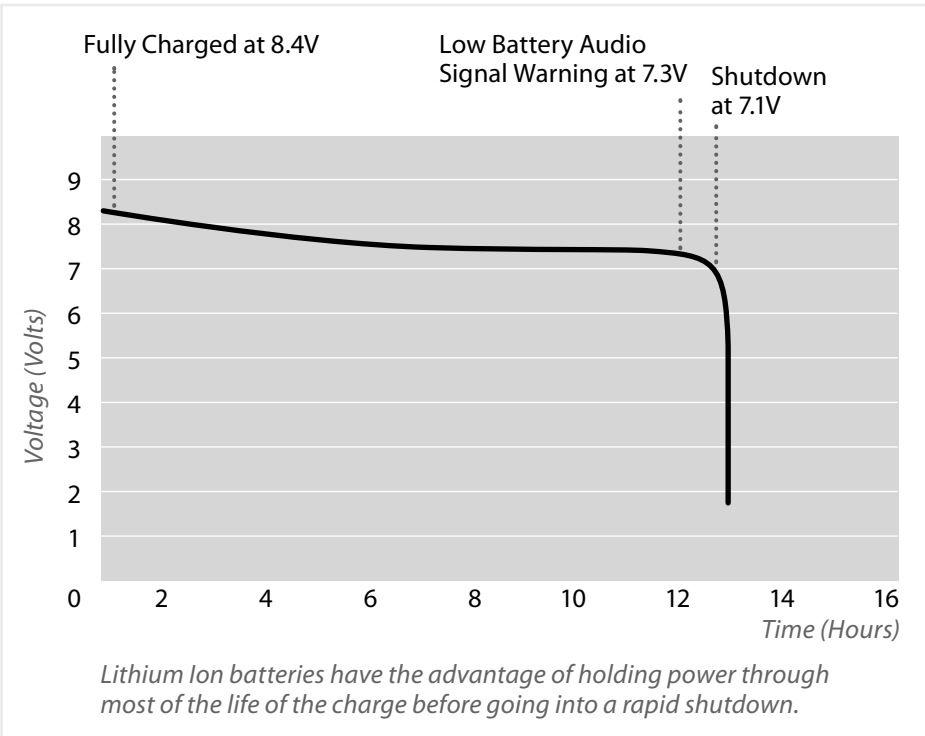

63 Manual Tune

Reducing Electrical Interference

(Auto Tune, pg. 33)

Range | **0 to 255**



Manual Tune allows you to select a particular channel, or you may want to fine tune the detector after performing an auto-tune. If detecting in a quiet area with no interference, you may find that you can select a channel at one end of the scale or the other. Low numbers are lower frequency channels and high numbers are higher frequency channels.

High frequency channels can give slightly more sensitivity to smaller targets close to the surface. Low frequency channels can give a little more depth to larger targets, but the difference is only marginal.

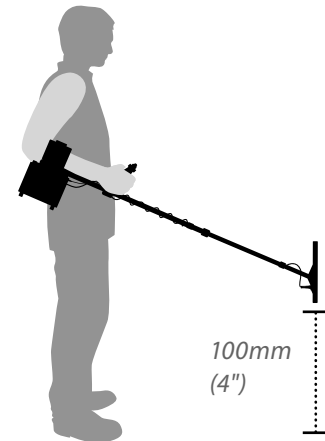

- 1 Hold the coil vertical and 100mm (4") above the ground, making sure there are no large targets or obvious electrical interferences close by.
- 2 Access the Manual Tune screen via the menu.
- 3 Slowly increase or decrease the numbers, pausing after each change to test the stability.
- 4 Listen to each channel in the range until you hear the least noise.

As it takes a while to go through the full range of band numbers, we recommend that you use the Manual Tune for fine adjustments after performing an Auto Tune.

If interference persists after tuning, try reducing the Gain setting, but in high interference areas you may need to use Cancel on the Coil/Rx switch.

A slower Motion speed will also reduce instability due to interference. (pg. 66)

If the setting control is turned quickly you will notice noise caused by rapid movement through the channels. This is normal and will not be present when the control is turned slowly.

Audio Type

Changing the Audio Response of Target Signals

Range | **Normal, Quiet, Boost, Deep**
 Factory Preset | Patch **Boost** General **Normal** Deep **Deep**

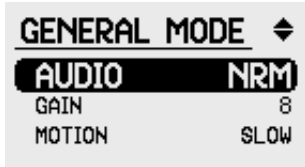

The Audio Type function replaces the Boost switch on the previous GP Series detectors. There are four options to choose from. Each setting changes the way that the detector interprets a signal and how that signal is produced as an audio response.



Normal

This may be used for general detecting conditions. Normal provides the best compromise for signal response and Threshold stability.



Quiet

This gives the most reduction of both ground noises and interference. The signal response is slightly quieter compared to the other Audio Types, so should only be used in the most extreme situations.

Boost

This is a more aggressive Audio Type. Boost will provide very sharp target signals but will also increase any signal caused by ground noises or electrical interference. It is best used in milder soils and well away from electrical interference.

Deep

This is the preferred Audio Type when searching for larger targets at depth. It works well in combination with the slower Motion options, where target signals come through loud and clear, but noises from ground and mineralisation are somewhat filtered out.

Note: Each Audio Type will have a different optimum Gain setting you should check the level of Gain if you make changes to Audio Type.

Gain

Adjusting the Sensitivity of the Detector

Range | **1 to 15**
 Factory Preset | Patch **7** General **8** Deep **9**

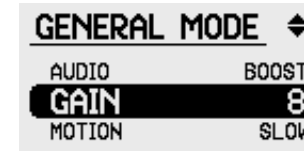

The Gain function allows the GPX-4000 to be optimised for differing conditions, controlling the sensitivity of the detector to its environment and to targets.

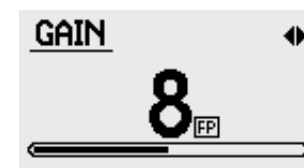

The detector, with a high Gain setting, will detect smaller and deeper targets but may respond to unwanted noise and ground signals. A high Gain setting is recommended for mild soil conditions and areas of low interference.

The detector, with a low Gain setting, will detect less unwanted noise and ground signals, but may miss deep targets. A lower Gain setting is preferable for variable 'noisy' conditions or high interference areas.

The Gain control should be adjusted to suit the soil conditions, as well as the coil being used. E.g. if you have found some nuggets in an area and wish to detect the same spot with a larger Monoloop coil, it may be necessary to reduce the Gain setting.

Always ensure that you are properly Ground Balanced and that the detector is tuned before making any changes to the Gain setting.

Note: Try using a slower Motion setting (pg. 66) and/or the Coil/Rx switch in Cancel (pg. 44) to allow a higher Gain setting.

Adjusting Sweep Speed

Range
Factory Preset

Very Slow, Slow, Medium, Fast
Patch **Med** General **Slow** Deep **V. Slow**

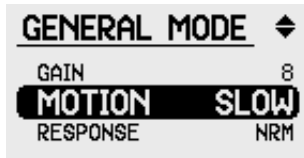

The speed at which you sweep the coil has an effect on target response time and Ground Balance adjustment. Matching your preferred coil sweep speed with the corresponding Motion setting can reduce noise.



Very Slow and Slow

When carefully detecting a small area, a slow Motion setting will allow for maximum depth and sensitivity to small targets. Slow Motion can be used in combination with a higher Gain and Deep or Boost Audio Type to achieve maximum performance.

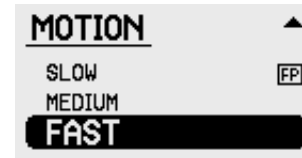

Medium

Is ideal for general detecting when normal 'slow & low' techniques are being used.

Fast

Fast is useful when using a fast sweep speed to cover ground quickly. In these circumstances, a quick sharp target response is used to alert the operator to a target. Fast will often have more ground noise but will allow you to cover more ground in a shorter amount of time.

Note: The Motion speed also effects how susceptible the detector is to external interference. Basically the slower the Motion speed, the less interference you will get, resulting in a smoother Threshold.

If you are using a Fast Motion and the Threshold is too unstable, you can either select Quiet Audio Type (pg. 64) or reduce Gain (pg. 65).

Inverting the Pitch of the Target Signal

Range
Factory Preset

Normal, Inverted

Patch **Normal** General **Normal** Deep **Inverted**

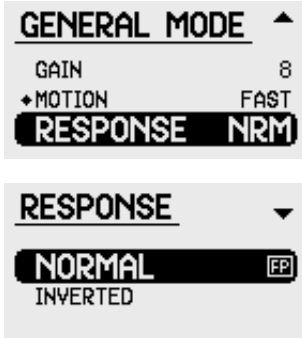

The Response function allows you to invert the normal pitch combination of target signals to different size targets.

If a person is used to hearing a rising and then falling tone sequence on small targets, and then goes to deep ground searching big nuggets, the target signal response can be inverted so that the larger deep targets are giving the target signal they are most used to listening for.

Normal

When Normal is selected and a small target is detected, the pitch normally rises to a higher pitch and then falls to a lower pitch. When a deep/large target is detected the pitch normally falls and then rises.

Inverted

When Inverted is selected and a small target is detected, the pitch will first fall to a lower pitch and then rise, and a deep/large target will first rise in tone and then fall.

Response is a personal preference and is quite dependant on a person's hearing.

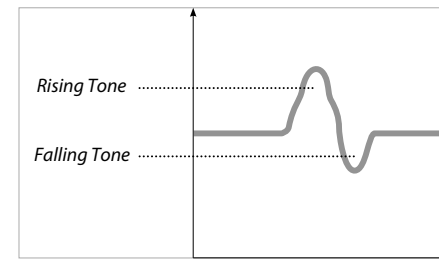

Normal (Small Target)

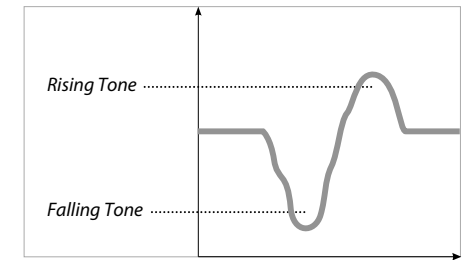

Normal (Deep Target)

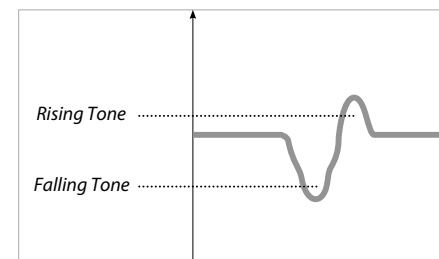

Inverted (Small Target)

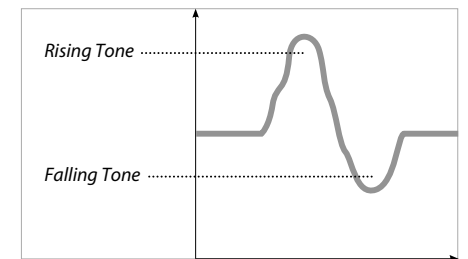

Inverted (Deep Target)

Pinpointing

Locating the Target

To find an object and reduce the size of the hole required to remove it from the ground, it is necessary to pinpoint the exact location of the object.

If a target is heard, first confirm it by setting an accurate Ground Balance away from the target and then pinpointing. To Ground Balance, if detecting in Fixed position, hold down the Quick-Trak button and pass the coil around the area of the target, making sure that the target is not detected (keep the coil well away from where the target is). Once completed release the button.

If detecting in Tracking, move the coil slowly around the area of the target, keeping well away from the target itself, then hold down the Quick-Trak button to go to Fixed and pinpoint across the target.

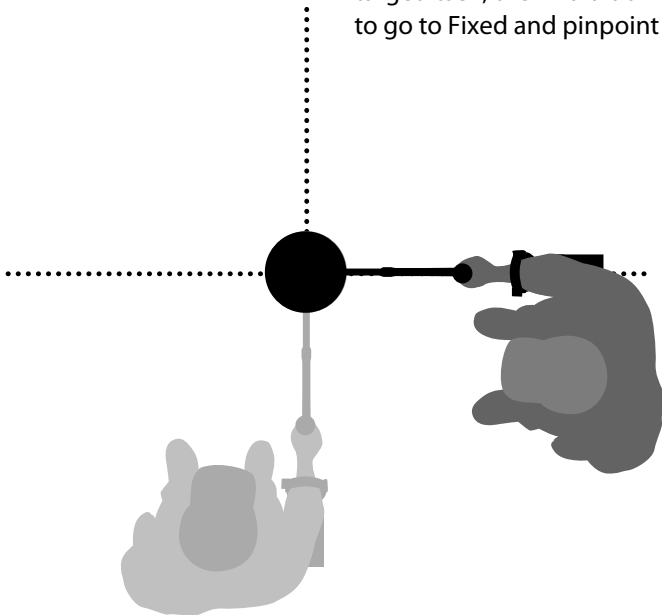

When a target is detected, sweep the general area with the coil, taking note of where the strongest signal is received.

By shortening the length of the sweep it should be possible to draw an imaginary line in the ground where the strongest signal is located.

Line up the target at 90° from the initial direction and repeat the process. The object is located where the two imaginary lines cross.

Note: With the Coil/Rx switch set to Monoloop or Cancel, pinpointing will not locate a target in the centre of the coil, the target will be slightly to the left.

Double-D Setting

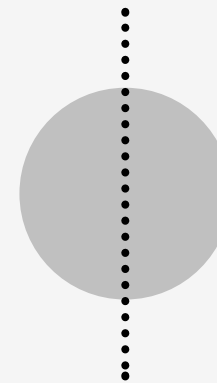

Strongest Signal

Monoloop (M) Setting (with DD coil)

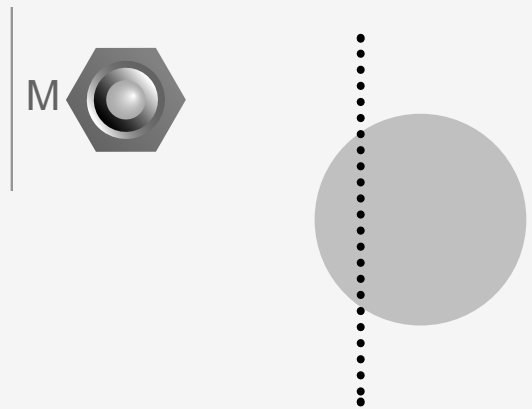

Strongest Signal

It is essential to carry at least one of the following digging tools with you when searching:

- a small, strong digging spade or shovel
- a pick with broad scraping blade
- a crowbar (for very deep objects in hard ground).



Backfill Every Hole You Dig

Always refill any holes and scatter leaves, before leaving the area. Help restore the area to its original condition. Any rubbish you recover should be taken away with you and disposed of properly.

Refilling holes and removing rubbish will help detector users maintain a good reputation. This should lead to more areas being readily accessible for prospecting.

When digging, avoid sharp edges to the hole as they can produce false signals, potentially masking the target. Slope the edges of the hole to avoid any problems.

Your hands and wrists must be free of any metallic jewellery and watches when passing dirt over the coil.

- 1 Clear the area of loose surface material and check that the target signal is still there. If it is not, the target should be amongst the moved surface material.
- 2 Remember if there are other signals close to your target. This is important so that when you come to dig your hole, you do not heap the loose dirt on top of another target already in the ground.
- 3 If the target signal is still present, use your pick to dig to a depth of approx. 50mm (2").
- 4 Sweep the coil over the hole to determine if it has been dug. If the target signal is not heard, then the target should be in the pile just dug. Otherwise dig a little deeper and check again.
- 5 Start digging approx. 100mm (4") in front of the target to reduce the chance of damaging it. Damaging a nugget may reduce its value.
- 6 If the target signal disappears from the hole, sweep the coil over the loose dirt and pinpoint its exact position.
- 7 Take a handful of the dirt and pass it over the coil.
- 8 If there is no signal, place the handful carefully in a new pile, pinpoint the position of the target again, and repeat with another handful of soil.
- 9 Once the target is in your hand, transfer half of the dirt to the other hand. Test each handful of dirt across the coil.
- 10 If the target is too small to see, drop the dirt onto the top of the coil and with your finger move any suspect objects. A target signal will only be given when the target is moved.

Follow these hints and techniques for better detecting and happy prospecting that will help you to utilise the power of your GPX-4000.

For Maximum Gold Recovery

Keep the coil as close to the ground as possible.

Listen carefully. This is more important than looking.

Slow down, do not rush, take your time.

Have a positive mind set, and imagine a nugget at every next sweep!

Remember that covering a small section of ground thoroughly will be more productive than randomly searching a larger area.

Identifying Target Signals

- Metallic targets will usually give a 'solid' sounding signal when the coil is swept across the object from any direction. A metallic target generally produces a short, sharp and mostly symmetrical signal. Ground noises usually give a broad uneven signal when the coil is swept from different directions and often may only give a signal from one direction and no signal on the return sweep.
- If you are not sure if the sound is ground noise or a target signal, you should investigate. Scrape a shallow hole about 70 - 100mm (2½" - 4") deep over the suspected target. Sweep the coil over the hole at the original ground level. Do not dip the coil into the hole. If the signal has decreased in volume or is less defined, it is probably ground noise. If the signal remains the same or becomes louder, it is likely a metallic target. If you are still not sure, make the hole deeper and repeat the process.
- A 'halo effect', which may be built up around a buried metal object, makes the object appear to be larger to the detector than it actually is. This will be reduced once the target is disturbed from its position in the ground (e.g. a small object, detected at a substantial depth, may be more difficult to detect once disturbed from the ground and lying in the loose dirt. If the object is reburied, the 'halo effect' will not be present).

Big Gold

Big Gold gives a much different response to the smaller shallower pieces. The signal is often quite broad, and there is very little pitch variance.

False Signals

If false signals are occurring as you sweep the coil, check that they are not produced by any metal that you are carrying, such as your pick, battery or steel toe boots.

Move the coil closer, and then further away from your body, in order to check if the signals are coming from these items. If they are, increase the distance between the coil and these items.

Avoid carrying metallic objects in your pants pockets as these are too close to the coil.

- Do not try to eliminate what might appear to be a faint, isolated ground noise by balancing the detector over the target because you may be 'balancing out' the target response from a deeply buried metallic target. It is better to Ground Balance around the target without going across it, then switch to Fixed and try Pinpointing.
- Dig all target signals, even in previously detected areas. The GPX-4000 has superior ground balancing and depth so it is possible to find new targets in well-worked areas where other detectors have been unable to cope with the high degree of mineralisation and/or salt.
- In some goldfields, a response may be received from a concentration of orange/reddish dyke material or clay. Remember, a metal target will get louder by moving the coil even centimetres closer.
- If detecting areas of extremely variable mineralisation, detect along the ground contours rather than across them. This will often stabilise the effect.
- In heavily mineralised areas the operator may need to sweep the coil 10 - 20 mm (½" - 1") above the ground. This should give a more stable Threshold and less ground noise.
- Very sudden or large changes in the mineralisation of an area may produce a signal from the detector. Usually this signal is very broad, and often only present in one direction.

The GPX-4000 is supplied with the 11" Double-D coil. This coil has an excellent combination of depth, sensitivity and stability.



10" x 5" Elliptical Double-D

This is the coil that every prospector should carry as its versatility is endless. Great in thick scrub, heavy mineralisation, and high trash, it has superb sensitivity, and surprising depth for such a small coil. It is also great for pinpointing deep targets found with one of the larger coils, and is extremely stable in all soils.

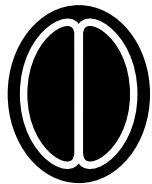

15" x 12" Semi - Elliptical Double-D

This coil has greater depth and ground coverage than the 11" DD, it provides stable operation in all soils. This is a great coil for all-round use in highly variable mineralisation, and a lighter, more manoeuvrable alternative to the 18" DD when seeking out large nuggets in heavy mineralisation. Its semi-elliptical design provides impressive sensitivity for its size.

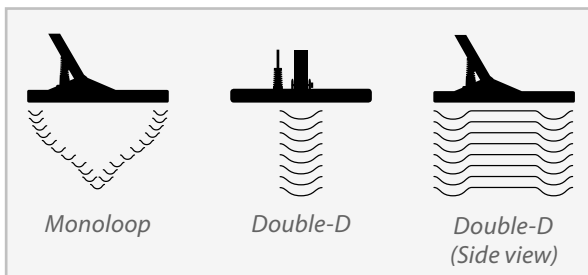

In addition to this there are also a number of other size coils now available to give improved performance to your detector. These range from smaller coils which give greater sensitivity to small targets and are lighter and manoeuvrable in heavy vegetation, up to larger coils which give greater depth.

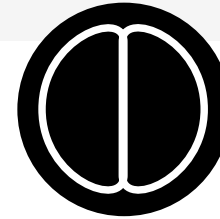

18" Round Double-D

A serious coil for the serious operator. The 18" Double-D punches deep through heavy mineralisation, while running smooth to allow you to hear those mellow, deep nugget responses.



8" Round Monoloop

The most sensitive of the Commander series, the 8" round provides the best depth on sub-gram nuggets in light to moderately mineralised soils. A popular coil for use on old diggings, it is also a great coil for detecting in heavy vegetation.

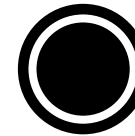

11" Round Monoloop

A lighter, more sensitive and deeper seeking coil compared to its Double-D brother, the 11" Monoloop is a brilliant coil for almost any situation. The second most sensitive Commander Monoloop, it is also one of the most stable Monoloop coils available, and remains stable in most soil types.

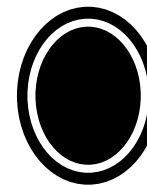

15" x 12" Semi - Elliptical Monoloop

On larger nuggets, this coil has better depth than the 11" Monoloop and the 15"x12" Double-D. It is very sensitive for its size. This coil is great for searching open areas for new patches, and also when seeking out deeper nuggets in areas that are too vegetated to allow effective use of the 18" Monoloop. It is an extremely stable coil and runs smooth in all but the worst soil conditions. This coil has already become a favourite for many operators.

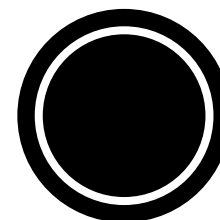

18" Round Monoloop

Superb depth and good sensitivity in low to medium mineralisation. This coil will find targets in heavily worked areas where other operators have given up.

Choosing the Right Coil for the Job

There are five main things that you should consider when deciding which coil is best for your terrain and target:

In some circumstances, non Minelab Double-D and Monoloop coils will work on the GPX-4000. However, there are limitations which means that some functions will not work properly. In some cases the use of coils not designed for the GPX-4000 may cause the detector to be unstable and noisy.

Coil Size and Depth

A larger coil will typically find targets buried deeper in the ground, but they can be less sensitive to smaller targets. A smaller coil is typically more sensitive to small targets, but does not go as deep as a larger coil.

Mineralisation

A Monoloop coil will often have improved performance over a Double-D coil but can be more difficult to Ground Balance and therefore possibly more noisy. A Double-D coil is often more stable in heavily mineralised areas.

Terrain and Vegetation







A small coil can be easier to manoeuvre through thick scrub or rough terrain. A smaller coil is also a lighter weight than a larger coil.

Discrimination

In areas where discrimination is required, a Double-D coil is needed for discrimination to work. In high trash concentrations, a smaller coil is preferable.

Search Pattern

A Double-D coil will typically provide a 'blade-like' detection pattern from the toe to the heel of the coil, which gives excellent ground coverage. A Monoloop coil has a detection field that is typically cone shaped, which requires overlapping of sweeps to ensure thorough ground coverage.

	Small, Shallow Nugget	Large, Deep Nugget	Highly Mineralised	Less Mineralised	Open Ground	Heavy Scrub	Iron Disc.
10" x 5" Elliptical Double-D 	Grey		Grey			Grey	Grey
15" x 12" Semi-Elliptical Double-D 		Grey	Grey		Grey		Grey
18" Round Double-D 		Grey	Grey		Grey		Grey
8" Round Monoloop 	Grey			Grey		Grey	
11" Round Monoloop 	Grey	Grey		Grey	Grey	Grey	
15" x 12" Semi-Elliptical Monoloop 		Grey		Grey			
18" Round Monoloop 		Grey		Grey	Grey		

<i>Main Menu:</i>	<i>Range:</i>	<i>User Preferences:</i>		
Volume Limit	1 to 40			
Audio Tone	1 to 100			
Signal Peak	1 to 20			
Track Speed	Slow Medium Fast			
GB Type	General Specific			
Sensitive	Extra Smooth			
Iron Reject	Off (All Metal) 1 to 30			
Battery Volts	-	-		
Manual Tune	0 to 255	-		
<i>Mode Edit:</i>		<i>General:</i>	<i>Patch:</i>	<i>Deep:</i>
Audio	Quiet Normal Boost Deep			
Gain	1 to 15			
Motion	Very Slow Slow Medium Fast			
Response	Normal, Inverted			

No sound	<ul style="list-style-type: none"> • Check that the detector is on (battery, power cable, connections and LCD) • Turn the Threshold control fully clockwise • Turn the Volume Limit to maximum (40) • Check that the headphones are plugged in • Try using a different set of headphones or a different battery
Threshold but no target signal	<ul style="list-style-type: none"> • Try testing different coils with a known target
Random noise	<ul style="list-style-type: none"> • Ground Balance again • Retune using the Auto Tune button • Set the Coil/Rx switch to Cancel • Reduce Gain • Move away from other detectors working nearby • Move away from thunderstorm build-up
Battery will not charge	<ul style="list-style-type: none"> • Check that there is power to the accessories socket using vehicle charger • Check the fuse in the 12V charger plug (M205-5A) • Check the battery LED patterns (<i>pg. 20</i>)
Battery not holding charge	<ul style="list-style-type: none"> • Try an alternative charger adaptor • Change the battery
'Coil Overcurrent' screen appears	<ul style="list-style-type: none"> • Turn the detector off, wait for a few seconds before turning it back on again

Control Box

This encloses the electronic circuitry of the detector. The control box generates the Tx (transmit) signals sent by the coil and processes the Rx (receive) signals detected by the coil. All user selectable functions are located on the front and rear panels of the control box.

Discrimination

The ability of a detector to determine if a located target is made from ferrous metal (iron or steel) or non-ferrous metal (non-magnetic).

Double-D Coils

Two windings of wire that overlap in the shape of two D's (one reversed). The characteristics of a Double-D coil are stability, especially in heavily mineralised ground, good depth and sensitivity and a very thorough search pattern.

Electromagnetic Field

Commonly called the 'signal from the coil'. An electromagnetic field is generated within the wire windings of the search coil and this field is pulsed or sent into the ground. The presence of a metal target in the ground will disturb the pattern of this field and this disturbance is sensed by the receive system of the detector and indicated to the operator by an audible 'beep'.

False Signals

These sound similar to target signals but are caused by other factors. Common causes for false signals are incorrect Ground Balance, hot rocks, signals caused by knocking the coil on obstacles, etc. With experience, the operator will learn methods to minimise false signals and to hear subtle differences between target signals and false signals.

Ferrous Metals

Metals composed of or containing iron. A ferrous item will be attracted to a magnet and is predominantly or completely made of iron or steel.

Ground Balance

The ability of the metal detector to compensate for the effects of ground mineralisation. The GPX-4000 has 'automatic Ground Balance'. When Ground Balance is used in the Tracking setting it continually compensates for changes in the ground mineralisation.

Halo Effect

After a metal object has remained undisturbed in the soil for a considerable amount of time, a diffusion occurs around the object. This has the effect of the object appearing to the detector to be a larger size.

Hot Rock

An individual rock which has a high degree of mineralisation in comparison to the surrounding ground around it. Due to this difference, the detector does not have the opportunity to Ground Balance to the individual hot rock so therefore gives a false signal. The signal will diminish rapidly by increasing the coil height above the hot rock.

Interference

Electricity or radio waves in the area being detected can cause instability or chattering of the Threshold. Interference commonly occurs due to power lines, underground cables, radar, other detectors or climatic conditions like thunderstorms.

Mineralisation

Most ground contains some minerals, which can cause false ground signals to be detected. Heavily mineralised ground requires different detector processing than does neutral or lightly mineralised ground. Ground containing heavy salt concentrations require entirely different processing again.

Monoloop Coils

Monoloop coils are the style of coil where the multiple strands of wire are wound in a single loop around the circumference of the coil. The field of search of Monoloop coils tends to be cone shaped. They provide greater depth and sensitivity compared to a Double-D coil of equivalent size in low-medium mineralisation.

Non-Ferrous Metals

Metals that do not contain significant levels of iron. Non-magnetic metals such as Gold, Silver, Copper, Brass, Lead or Aluminium.

Pinpoint

The method of determining the precise location of a target prior to digging. Pinpointing uses the design of the search coil windings to determine the exact position of the detected target.

Rx (Receive)

Refers to the response or electromagnetic field which is received back by the coil and is used by the control box circuitry to detect a metal item in the ground.

Glossary of Terms (Continued)

Salt Mineralisation

Salt content in the ground causes a negative (-) response rather than the positive (+) response of laterite soils.

A large salt content in the ground will have a different effect on the detector than other types of mineralisation. Therefore the detector needs to use different filtering techniques to overcome this effect.

Search Coil

The search coil is the circular plate which is swept across the ground surface during detecting. It transmits electromagnetic signals into the ground and receives the response.

Search Pattern

The search pattern is the area of ground underneath the coil which is being scanned. Depending on the style of coil (Double-D or Monoloop) and the Coil/Rx setting being used (Double-D/Monoloop/Cancel), different coils will have a different shaped area being covered by each sweep.

Threshold

The continuous audible level of sound emitted by the detector is referred to as the Threshold. Threshold can be set anywhere between silent and loud, but a soft, audible level is normally suggested.

Target Signal

This is a change in the tone (pitch) and volume of the Threshold when a target is detected and not discriminated (rejected).

Tracking

The function of automatic Ground Balance where the detector makes continuous adjustments to the Ground Balance to compensate for changes in the mineralisation of the ground.

Tx (Transmit)

This refers to the transmit signals or electromagnetic pulses, sent into the ground by the coil.

Taking Care of Your Detector

(Taking Care of your Battery, pg. 21)

The GPX-4000 is a high quality electronic instrument. Take care of your detector in the following way:



The control box is water resistant, but not waterproof. Keep all electrical connectors clean and dry.

The coil may be used in light rain but take care not to immerse it in water.

The control box and coil should not come into contact with petrol or other oil-based liquids.

Regularly remove loose dirt and dust from the control box using a dry paint brush. Clean the detector shaft and coil with a damp cloth using a mild soap detergent. Do not use solvents.

The coil housing will eventually wear through if you scrub the ground with it while searching. Use of a replaceable skid plate will help to protect your coil. Regularly replace such items as coil washers and skidplates to increase the life to your detector.

To prevent dirt entering between the coil and the skidplate, silk tape, e.g. Leukosilk®, which is available from chemists, may be used. The use of some other carbon based tapes, e.g. insulation tape, may result in some loss of sensitivity.

Do not expose the detector to high temperatures or leave it in the sun for longer than is necessary. Shading will help protect it. Do not leave the detector in a closed vehicle, especially in the sun.

Do not open the control box as this will void your warranty. All control box, battery and coil repairs should be sent back to Minelab or a Minelab authorised repairer.

Detector

Transmission	Bi-Level Pulse Induction
Technology	MPS Dual Voltage Technology
Coil (Standard)	11" Round Double-D
Audio Output	6.35mm (¼") headphone socket Headphones supplied
LCD	64x128 pixels Non-backlight reflective
Length	Extended: 1300 mm Unextended: 1100 mm
Weight Including 11" Coil, (Excluding Battery and Accessories)	2.4 kg
Operating temperature range	0°C to 45°C
Storage temperature range	-20°C to +65°C

Battery

Type	Lithium Ion
Output Voltage	7.4VDC, 8.4V DC when fully charged. Max discharge current is 1A
Capacity	9.2 Ah
Input (Charge)	12-24V DC / 2-3 A
Weight	870g
Operating temperature range	0°C to 45°C
Storage temperature range	-5°C to 65°C max, preferred: 5°C to 25°C.
Battery charge temperature range:	0°C to 45°C

The GPX-4000 control box has a 2 year warranty covering parts and labour.

The GP series / Commander coils have a warranty for one year against malfunction.

The commencement of the warranty is the date of purchase. Refer to the Product Warranty card for specific details.

The Minelab warranty does not cover damage caused by accident, misuse, neglect, modifications or unauthorised service.

This warranty is not transferable. The enclosed warranty registration card needs to be returned to Minelab Electronics Pty. Ltd. or an authorised Minelab Electronics Pty. Ltd. regional distributor within 14 days of the original purchase date.

If you need to return your detector to Minelab for service, please fill out the Minelab Service Repair Form. Please supply your name, address and phone number along with purchase date and serial number when sending detector parts for repair. Supply as much detail about the fault as possible to assist our service engineers to rectify the problem quickly and efficiently. Return the form with the detector / parts in a cardboard box for protection.

Do not open the control box as this will void your warranty.

It is the responsibility of the owner to pay all transport costs for the detector to Minelab.

The repaired detector will be returned to the owner freight free.

